



[www.sauer-qualityparts.com](http://www.sauer-qualityparts.com)

## ASSORTIMENT

Truck en Trailer onderdelen

## Inhoudsopgave

Schijfremblokken set .....	3
Remvoeringen .....	15
Remschijven .....	21
Remtrommels .....	31
Luchtbalgen .....	39
Schokdempers .....	59
Fijnregelaars .....	73
Velgen .....	79
Luchtketels .....	81
Smeermiddelen .....	99
Remcilinders .....	101
Steunpoten .....	107
Hub Units .....	111
Vervangingsset remklauw .....	113
REMAN – Remklauwen .....	121



[www.sauer-qualityparts.com](http://www.sauer-qualityparts.com)



## SCHIJFREMBLOKKEN SET

Truck en Trailer onderdelen

## Schijfremblokken set

	Onderdeelnummer ①	WVA	Ref. Nr. OEM ②	Toepassing	Geschikt voor
	S0572903000	29030 29113 29083 29084 29053 29210	8285388435	Kässbohrer	Elsa1 / D3 - 22,5"
			51508205040	MAN	
			81508080003	MAN	
			81508205006	MAN	
			81508205007	MAN	
			81508205020	MAN	
			81508205021	MAN	
			81508205044	MAN	
			81508205047	MAN	
			81508205060	MAN	
			81508205066	MAN	
			81508205068	MAN	
			81508205087	MAN	
			81508205091	MAN	
			81508206000	MAN	
			81508206002	MAN	
			81508206004	MAN	
			81508206014	MAN	
			81508206016	MAN	
			81508206017	MAN	
			81508206025	MAN	
			81508206034	MAN	
			81508206035	MAN	
			81508206036	MAN	
			81508206044	MAN	
			81508206046	MAN	
			81508206064	MAN	
			A0024200820	Mercedes Benz	
			A0024205520	Mercedes Benz	
			A0024205520	Mercedes Benz	
			A0034205520	Mercedes Benz	
			A0034208420	Mercedes Benz	
A0068320504	Mercedes Benz				
A0068325023	Mercedes Benz				
A0068325166	Mercedes Benz				
A8285408463	Mercedes Benz				
A82854084630	Mercedes Benz				
A8285408534	Mercedes Benz				
A82854085340	Mercedes Benz				
5001823000	Renault				
5001834075	Renault				
5001854341	Renault				
5001854342	Renault				

① Zie pagina 4

② De originele onderdeelnummers dienen alleen voor vergelijkingsdoeleinden en identificatie.





## Schijfremblokken set

	Onderdeelnummer ①	WVA	Ref. Nr. OEM ②	Toepassing	Geschikt voor	
	S0572905900, S0572905910 (met padhouder)		204552	Bova	SB7 / SN7 - 22,5"	
			0203121400	BPW		
			0203121700	BPW		
			0536270010	BPW		
			0536270020	BPW		
			0980102200	BPW		
			0980102570	BPW		
			0980102920	BPW		
			0980106200	BPW		
			0980106360	BPW		
			1439324	DAF		
			1439324S1	DAF		
			1617343	DAF		
			1617343S1	DAF		
			1797053	DAF		
			1800830	DAF		
			1878030	DAF		
			1982826	DAF		
			1906438	Iveco		
			1906439	Iveco		
			2992348	Iveco		
			2992476	Iveco		
			2995637	Iveco		
			2995809	Iveco		
			2995819	Iveco		
			2996378	Iveco		
			29105	Iveco		
			29106	Iveco		
			29108	8285000571		Kässbohrer
			29109	8285515573		Kässbohrer
			29179	81505206055		MAN
			29202	81505206056		MAN
			29042	81505206065		MAN
			29196	81508205099		MAN
			29154	81508206030		MAN
			29163	81508206032		MAN
			29201	81508206033		MAN
			29275	A0004206020		Mercedes Benz
				A0004214310		Mercedes Benz
				A002420222010		Mercedes Benz
				A0024204920		Mercedes Benz
				A0034201620		Mercedes Benz
				A0034202020		Mercedes Benz
				A0034203520		Mercedes Benz
				A0044206020		Mercedes Benz
		A0064201120	Mercedes Benz			
		82134000	Neoplan			
		82135100	Neoplan			
		03057007700	SAF			
		1390428	Scania			
		1521979	Scania			
		1527633	Scania			
		1734529	Scania			
		1856108	Scania			
		016785	Schmitz			
		017251	Schmitz			
		1182462	Schmitz			
		1182957	Schmitz			
		09317202	SMB			

① Zie pagina 4

② De originele onderdeelnummers dienen alleen voor vergelijkingsdoeleinden en identificatie.



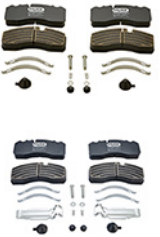

## Schijfremblokken set

	Onderdeelnummer ①	WVA	Ref. Nr. OEM ②	Toepassing	Geschikt voor
	S0572908800	29088 29091 29285	1436901 1502006 1906467 2996430 81508205011 81508205023 81508205025 81508205029 81508206006 81508206020 81508206042 5001866951 5010848607	DAF DAF Iveco Iveco MAN MAN MAN MAN MAN MAN MAN Renault Renault	PAN 17 - 17,5"
	S0572909000	29090	5001831161 5001833114 5001846034 5001865750 68321345 20825594 20850194 3093919 3093939 85105485 8550611 85506111	Renault Renault Renault Renault Renault Volvo Volvo Volvo Volvo Volvo Volvo Volvo	Lucas D-Lisa - 22,5"
	S0572909500, S0572909510 (met padhouder)	29095 29093 29094 29184 29197	0020311500 0020311600 0203121600 1519637 1529337 M91000101 2992336 2996468 JAE0250407820 81508205017 81508205094 81508205098 81508206008 81508206022 81508206058 81508206059 81508206060 A0004210710 A0004210810 A0004215010 A0024207820 A0024207920 A0044201320 A0054202320 03057007800 017572 1087988 09291024SB6000 41142152	BPW BPW BPW DAF DAF Fruehauf Iveco Iveco Jost MAN MAN MAN MAN MAN MAN MAN MAN Mercedes Benz Mercedes Benz Mercedes Benz Mercedes Benz Mercedes Benz Mercedes Benz Mercedes Benz SAF Schmitz Schmitz SMB VDL	SB6 / SN6 - 19,5"

① Zie pagina 4

② De originele onderdeelnummers dienen alleen voor vergelijkingsdoeleinden en identificatie.



## Schijfremblokken set

	Onderdeelnummer ①	WVA	Ref. Nr. OEM ②	Toepassing	Geschikt voor
	S0572912200	29065 29122 29374 29067 29302	1522201 1906144 1906297 1906298 1906402 1906416 1909291 19092981 42555669 5001014694 5001825638 5021136005	Iveco Iveco Iveco Iveco Iveco Iveco Iveco Iveco Iveco Renault Renault Renault	Lucas - 17,5" (zonder accessoires)
	S0572912400	29124 29155	MDP1314 MDP5076 15224835	MERITOR / ROR	DX 195 - 19,5"
	S0572912500	29125 29277	1078439 3095396 20768092 20918891 20931343 20932682 21088907	Volvo	D Duco / Lucas - 22,5"
	S0572912600	29126 29159 29168 29313	1609191 1628064 5021170489 03057008000 03057008001 1100810 50320001	DAF DAF Renault SAF SAF Schmitz VALX	PAN 19-1 - 19,5"

① Zie pagina 4

② De originele onderdeelnummers dienen alleen voor vergelijkingsdoeleinden en identificatie.



## Schijfremblokken set

	Onderdeelnummer ①	WVA	Ref. Nr. OEM ②	Toepassing	Geschikt voor
	S0572913100	29131 29156	02996065 02996068 500024112 5006028410 503136113 503142454 81508205039 81508205072 81508205073 81508205080 81508206031 81508206041 81508206051 81508206052 68324558 68324957 68325344 68325346 68325901 68326015 5001020312 5001855646 5001863904 5006028410 8001863904 15227419T 68324558NZP 20535922 20976509 21309468 85107768	Iveco Iveco Iveco Iveco Iveco Iveco MAN MAN MAN MAN MAN MAN MAN MAN MAN MAN MAN MERITOR / ROR MERITOR / ROR MERITOR / ROR MERITOR / ROR MERITOR / ROR MERITOR / ROR Renault Renault Renault Renault Renault Rockwell Rockwell Volvo Volvo Volvo Volvo	Lucas / Elsa2 - 22,5"
	S0572913700	29137	20768115 3093530 3093532	Volvo	C Duco - 19,5"

① Zie pagina 4

② De originele onderdeelnummers dienen alleen voor vergelijkingsdoeleinden en identificatie.

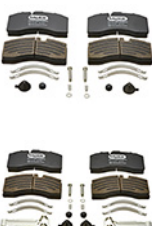



## Schijfremblokken set

	Onderdeelnummer ①	WVA	Ref. Nr. OEM ②	Toepassing	Geschikt voor
	S0572914800	29115 29116 29148 29183	0980107070 81508205074 81508205085 81508206040 81508206043 81508206054 81508206063 A0004211010 A0004211210 A0014210510 A0014210610 A0014212510 A0014212610 A0034201120 A0034201220 A0034206620 A0034207220 A0034207320 A0044206120 A0084206520 A0084206620	BPW MAN MAN MAN MAN MAN MAN Mercedes Benz Mercedes Benz Mercedes Benz Mercedes Benz Mercedes Benz Mercedes Benz Mercedes Benz Mercedes Benz Mercedes Benz Mercedes Benz Mercedes Benz Mercedes Benz Mercedes Benz	SB5 / SN5 - 17,5"
	S0572915800, S0572915810 (met padhouder)	29158 29269	JAE0250407020 JAE0250427020 A0004202582 A0044207020 03057008500 1748114 2339722 1005316 1008452 1105625 1161563	Jost Jost Mercedes Benz Mercedes Benz SAF Scania Scania Schmitz Schmitz Schmitz Schmitz	SK7 - 22,5"
	S0572916200, S0572916210 (met padhouder)	29162 29336	871673 877935 5021209104 03057008400 03057008401 03057008402 2432075 1011906 1068118 1101449 1195232 1331649 50320002	DAF DAF Renault SAF SAF SAF Scania Schmitz Schmitz Schmitz Schmitz Schmitz Valx	PAN 22-1 - 22,5"

① Zie pagina 4

② De originele onderdeelnummers dienen alleen voor vergelijkingsdoeleinden en identificatie.

## Schijfremblokken set

	Onderdeelnummer ①	WVA	Ref. Nr. OEM ②	Toepassing	Geschikt voor
	S0572917300	29173 29203 29272	1534094 1962588 906206 5001864365 7421399915 7421496556 20526569 20560414 20568712 20568715 21352573 21496551	DAF DAF DAF Renault Renault Renault Volvo Volvo Volvo Volvo Volvo	Elsa 225-1 - 22,5"
	S0572917400	29174 29204 29218 29226 29273 29187 29219 29334	1524600 1534095 1962267 1962589 5001864363 5001864364 7421399929 7421496555 20526568 20560412 20568711 20568714 21024701 21024702 21352570 21496550	DAF DAF DAF DAF Renault Renault Renault Renault Volvo Volvo Volvo Volvo Volvo Volvo Volvo	Elsa 225-3 - 22,5"
	S0572917700	29177 29169	68324665M13 68325492 5001864380 7420560415 7421496557 7422921066 20586713 20765963 21496552	MERITOR / ROR MERITOR / ROR Renault Renault Renault Volvo Volvo Volvo	Elsa 195 - 22,5"
	S0572918100	29181 29147 29207	5001866914 5010598372 9291073 20780788 20844903	Renault Renault SMB Volvo Volvo	DB19 - 19,5"
	S0572919510	29195 29175 29274	1962437 6609982 550016447 550017646 03057009600	DAF Kögel Krone Krone SAF	SBS 2220H0

① Zie pagina 4

② De originele onderdeelnummers dienen alleen voor vergelijkingsdoeleinden en identificatie.







## Schijfremblokken set

	Onderdeelnummer ①	WVA	Ref. Nr. OEM ②	Toepassing	Geschikt voor
	S0572922700	29227 29316	0480107550 0509290120 0509290121 0900061789 0900061790 0980107550 0980107561 0980107940 0980107951 550017150	BPW BPW BPW BPW BPW BPW BPW BPW BPW Krone	TSB 3709
	S0572922800	29228 29317 29355	0509290130 0509290131 0900061791 0980107570 0980107960 0980107971 0980107971 550017097	BPW BPW BPW BPW BPW BPW BPW Krone	TSB 4309
	S0572924400, S0572924410 (met padhouder)	29244	A0064201520 A0064205320	Mercedes Benz	SL7
	S0572924600, S0572924610 (met padhouder)	29246	A0064201420 A0064205220	Mercedes Benz	SM7
	S0572927900	29279 29223 29337	81508206065 81508206066 81508205108 81508205112	MAN	MAXX-22
	S0572930600	29306 29165	0509290040 0509290050 0509290100 0509290220 0980102750 0980102930 0980106210 0980106350 0980106430 0980107090 0980107240 0980108150	BPW	SB6 / SN6 - 19,5"

① Zie pagina 4

② De originele onderdeelnummers dienen alleen voor vergelijkingsdoeleinden en identificatie.



## Schijfremblokken set

	Onderdeelnummer ①	WVA	Ref. Nr. OEM ②	Toepassing	Geschikt voor
	S0572930700	29307 29270 29263 29216 29167	0509290070 0509290090 0536270020 0980102570 0980102920 0980106200 0980106360 0980106450 0980106960 0980107250 0980107280 0980108170 0980108171 0509290240	BPW	SB7 / SN7 - 22,5"
	S0572930800	29308 29271 29264	0509290060 0509290080 0509290230 0980106440 0980106950 0980107260 0980108160 0980107280 0980108150 0980108151 0980108161	BPW	SK7 - 22,5"
	S0572932800, S0572932810 (met padhouder)	29328 29329 29318 29319	03057000600 1178243 1227590	SAF Schmitz Schmitz	ST7 - 22,5"
	S0572933110 (met padhouder)	29331 29394	2325212 2325213 2271804 1890861 1856108 1734529 1527633 1521979 1390428	Scania	SN7 HP
	S0572933610 (met padhouder)	29336	1195232 1331649	Schmitz	MAXX - 22T

① Zie pagina 4

② De originele onderdeelnummers dienen alleen voor vergelijkingsdoeleinden en identificatie.

## Schijfremblokken set

	Onderdeelnummer ①	WVA	Ref. Nr. OEM ②	Toepassing	Geschikt voor
	S0572934010 (met padhouder)	29340	JAE0250410020	Jost	DCA-L7 - 22,5"
	S0572934510 (met padhouder)	29345 29315	A0084206420 A0084206320 A0014215210	Mercedes Benz	MAXX - 22L HD

① Zie pagina 4

② De originele onderdeelnummers dienen alleen voor vergelijkingsdoeleinden en identificatie.







[www.sauer-qualityparts.com](http://www.sauer-qualityparts.com)



## REMVOERINGEN

Truck en Trailer onderdelen

## Remvoeringen

	Onderdeelnummer ①	WVA	Ref. Nr. OEM ②	Toepassing	Afmetingen mm	Dikte mm	ECE-R 90
	S0571903200	19032	0309226010 0309226060 0309226100 0309226110 0309226210 0309226250 0309226260 0309226320 0309226480 0309226560 0309226660 0309226760 0309226850 0309264500 0509126900 0509126950 0509146090 303910 08241999328 08241999733 5000814836 5000823921 03057391200 1095142	BPW BPW BPW BPW BPW BPW BPW BPW BPW BPW BPW BPW BPW BPW BPW BPW BPW DAF Kässbohrer Kässbohrer Renault Renault SAF Schmitz	420 x 180	17,5	✓
	S0571903600	4x 19036 4x 19037	21200790B 21200791B 21222416R 21222417R	MERITOR / ROR	419 x 177,8	18,6	✓
	S0571907100	19071 19939	1522138 5001868089 7421534386 89200340825 270836 2708361 270942 2709426 270976 2709765 3093259 3093263 3095169 3095179 3095189	DAF Renault Renault Steyr Volvo Volvo Volvo Volvo Volvo Volvo Volvo Volvo Volvo Volvo Volvo	414 x 200	18,6	✓

① Zie pagina 16

② De originele onderdeelnummers dienen alleen voor vergelijkingsdoeleinden en identificatie.

① Dit zijn SAUER QUALITY PARTS onderdeelnummers. Het zijn geen originele OEM of OEM geautoriseerde producten, maar het is een Aftermarket product.



## Remvoeringen

	Onderdeelnummer ①	WVA	Ref. Nr. OEM ②	Toepassing	Afmetingen mm	Dikte mm	ECE-R 90
	S0571909400	19094	0309227010 0309227060 0309227150 0309227180 0309227190 0309227240 0309227260 0309227430 0309227450 0309227530 0309227650 0309227710 0309227760 0309227950 681971 702971 8241016237 8241999325 8241999735 5000814837 5000823922 5000823929 5000829360 03057241300 03057301300 03057391300	BPW BPW BPW BPW BPW BPW BPW BPW BPW BPW BPW BPW BPW DAF DAF Kässbohrer Kässbohrer Kässbohrer Renault Renault Renault Renault SAF SAF SAF	420 x 200	17,5	✓
	S0571928300	4x 19283 4x 19284	03057306000 03057396000 017548	SAF SAF Schmitz	420 x 180	19,9 / 19,8	✓
	S0571947700	4x 19477 4x 19478	03057306600 03057396600 1004668	SAF SAF Schmitz	420 x 200	19,9	✓

① Zie pagina 16

② De originele onderdeelnummers dienen alleen voor vergelijkingsdoeleinden en identificatie.



## Remvoeringen

	Onderdeelnummer ①	WVA	Ref. Nr. OEM ②	Toepassing	Afmetingen mm	Dikte mm	ECE-R 90
	S0571949500	2x 19495 6x 19487	81502200524	MAN	410 x 183	17	✓
			81502200551	MAN			
			81502200664	MAN			
			81502200665	MAN			
			81502210058	MAN			
			81502210181	MAN			
			81502210219	MAN			
			81502210441	MAN			
			81502210451	MAN			
			81502210526	MAN			
			81502210645	MAN			
			81502210771	MAN			
			81502210784	MAN			
			81502210809	MAN			
			81502210850	MAN			
			81502210855	MAN			
			81502210906	MAN			
			81502210908	MAN			
			81502216077	MAN			
			81502216078	MAN			
			81502216097	MAN			
			81502216114	MAN			
			A3464234810	Mercedes Benz			
			A3464235710	Mercedes Benz			
			A3464239610	Mercedes Benz			
			A3464239710	Mercedes Benz			
			A6174231111	Mercedes Benz			
			A6174231211	Mercedes Benz			
			A6174231330	Mercedes Benz			
			A6174231511	Mercedes Benz			
			A6174231710	Mercedes Benz			
			A6174232311	Mercedes Benz			
			A6174232711	Mercedes Benz			
			A6174232811	Mercedes Benz			
A6174235911	Mercedes Benz						
A6174236011	Mercedes Benz						
A6174236311	Mercedes Benz						
A6174236411	Mercedes Benz						
A6174239110	Mercedes Benz						
A6594231610	Mercedes Benz						
A6594231610	Mercedes Benz						
A6594232310	Mercedes Benz						
A6594232510	Mercedes Benz						
A6594234110	Mercedes Benz						

① Zie pagina 16

② De originele onderdeelnummers dienen alleen voor vergelijkingsdoeleinden en identificatie.



## Remvoeringen

	Onderdeelnummer ①	WVA	Ref. Nr. OEM ②	Toepassing	Afmetingen mm	Dikte mm	ECE-R 90
	S0571949600	2x 19496 6x 19488	81502006828 81502200661 81502200662 81502200663 81502210446 81502210531 81502210650 81502210681 81502210814 81502210860 81502210865 81502210913 81502210921 81502216081 81502216101 81502216101 81502216117 81502216118 88502200040 A6174230030 A6174230530 A6174235510 A6174235511 A6174236210 A6174239510 A6177233111 A6594231210 A6594233610 A6594233710 A659423371067	MAN MAN MAN MAN MAN MAN MAN MAN MAN MAN MAN MAN MAN MAN MAN MAN MAN MAN Mercedes Benz Mercedes Benz Mercedes Benz Mercedes Benz Mercedes Benz Mercedes Benz Mercedes Benz Mercedes Benz Mercedes Benz Mercedes Benz Mercedes Benz Mercedes Benz	410 x 223	17	✓
	S0571951500	4x 19515 4x 19516	03057312400 03057392400 1076664	SAF SAF Schmitz	300 x 200	16,3	✓
	S0571957400	19574	0309214120 0309214130 0309214230 0309214270 0309214280 0309214330 0309214340 0309214440 0309214450 0309214450 0309214460 8241999686	BPW BPW BPW BPW BPW BPW BPW BPW BPW BPW BPW Kässbohrer	300 x 200	17,5	✓

① Zie pagina 16

② De originele onderdeelnummers dienen alleen voor vergelijkingsdoeleinden en identificatie.

## Remvoeringen

	Onderdeelnummer ①	WVA	Ref. Nr. OEM ②	Toepassing	Afmetingen mm	Dikte mm	ECE-R 90
	S0571993200	19932	1535249 551123 551124 551138 551162 552114 1109003 1535253 385949 551192	Scania	413 x 203	19	✓
	S0571993300	19933	1535250 1535254 551125 551163 552116 551180 385950	Scania	413 x 254	19	✓

① Zie pagina 16

② De originele onderdeelnummers dienen alleen voor vergelijkingsdoeleinden en identificatie.



[www.sauer-qualityparts.com](http://www.sauer-qualityparts.com)



## REMSCHIJVEN

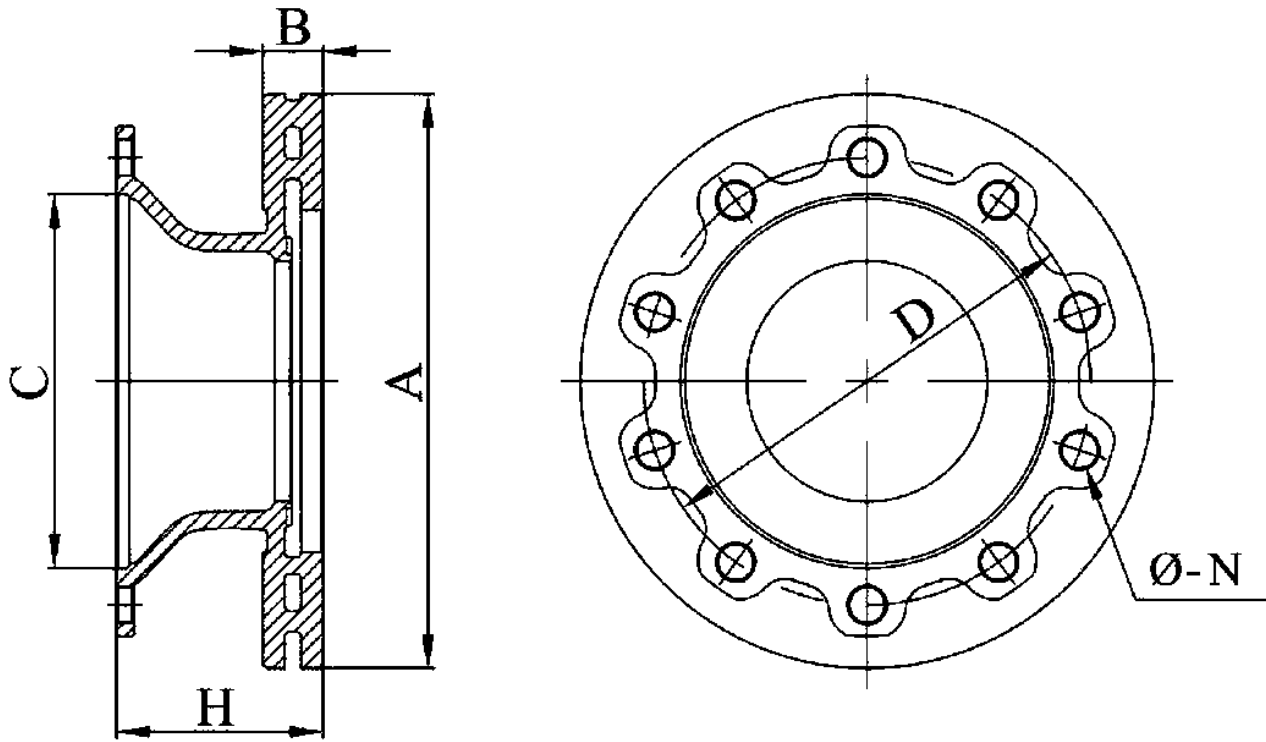

Truck en Trailer onderdelen



X – Minimale dikte







## Remschijven

	Onderdeelnummer ①	Ref. Nr. OEM ②	Toepassing	A	B	C	H	D	Ø N	X	Aantal gaten
	S0790100300	800218 04079000300 04079000350 1004657	Kögel SAF SAF Schmitz	430	45	0	160,5	335	22,75	37	10
	S0790100400	6500512 550003903 04079000400 04079000450 016285	Kögel Krone SAF SAF Schmitz	377	45	211	157,5	275	23	37	8
	S0790100500	6500481 801951 345553 A9424211312 04079000500 04079000502 04079000501 04079000552 017347 1009863 015733	Kögel Kögel Kögel Mercedes Benz SAF SAF SAF SAF Schmitz Schmitz Schmitz	430	45	196,3	130	168	19	37	12
	S0790100700	801926 04079000703 04079000700 04079000702 04079000701 04079000753 017249 1091853	Kögel SAF SAF SAF SAF SAF Schmitz Schmitz	377	45	196,1	139,5	168	19	37	12
	S0790101000	6500482 04079001000 04079001001 04079001002 04079001003 04079001004 04079001054	Kögel SAF SAF SAF SAF SAF SAF	376	45	189	57,5	190	13,5	37	10
	S0790101300	6604093 550016520 04079001353 04079001300 04079001303 1099708	Kögel Krone SAF SAF SAF Schmitz	430	45	198,5	48	190	13,5	39	10

① Zie pagina 23

② De originele onderdeelnummers dienen alleen voor vergelijkingsdoeleinden en identificatie.







## Remschijven

	Onderdeelnummer ①	Ref. Nr. OEM ②	Toepassing	A	B	C	H	D	Ø N	X	Aantal gaten
	S0790101700	6607394 550016521 04079001700 04079001701 04079001751 1142408	Kögel Krone SAF SAF SAF Schmitz	430	45	189,1	131,5	215	M14x1,5	37	10
	S0790101800	6610116 04079001800 04079001801 04079001851 1118535	Kögel SAF SAF SAF Schmitz	377	45	189,1	141	215	M14x1,5	37	10
	S0790203700	0308834037 0308834030 0308834157 0308834167 0308834010 0308834017 0308834090 0308834097 0308834150 0308834160 1044621	BPW BPW BPW BPW BPW BPW BPW BPW BPW BPW Schmitz	377	45	230	159,5	275	23	37	8
	S0790204000	0308834040 0308834047 0308834020 0308834067 0308834060 0308834027 0300224093 016115 016706 018211	BPW BPW BPW BPW BPW BPW BPW Schmitz Schmitz Schmitz	378	45	290	159,5	335	23	37	10
	S0790205000	6603952 0308835030 0308835037 0308835050 0308835057 0308835120 0308835127 0308835058 0308835128 017586 5021200841	Kögel BPW BPW BPW BPW BPW BPW BPW BPW Schmitz Renault	430	45	300	159,5	335	22,5	37	10

① Zie pagina 23

② De originele onderdeelnummers dienen alleen voor vergelijkingsdoeleinden en identificatie.







## Remschijven

	Onderdeelnummer ①	Ref. Nr. OEM ②	Toepassing	A	B	C	H	D	Ø N	X	Aantal gaten
	S0790208700	0308834080 0308834087 017163 6501461	BPW BPW Schmitz Kögel	377	45	290	169,5	335	23	40	10
	S0790210000	0308834100 0308834107 0308834147 0308834217 0308834140 0308834210 0308834148 0308834218 6500614 6608791 550019027	BPW BPW BPW BPW BPW BPW BPW Kögel Kögel Krone	376,4	45	300	159,4	335	22,5	41	10
	S0790213700	0308834130 0308834137 0308834100 0308834107 6500614	BPW BPW BPW BPW Kögel	377	45	298	159,5	335	23	37	10
	S0790301200	A6754210012 A6754210112 1002522 JAE0110400012	Mercedes Benz Mercedes Benz Schmitz Jost	377	45	211	131,5	238	M14x1,5	37	10
	S0790311210	A9754210012 A9754210112 A9754210212 A6754210112 A9754210512 A9754212112	Mercedes Benz	377	45	168	134	138	M14x1,5	37	14
	S0790321200	A9424212112 A9424211212 A9424210912 A9424230012 A9424211112 A9424230112 A9424212612 A9424211012 A9424212312 A0001134600 A6954230512 6503150 A9424212512 JAE0110400112	Mercedes Benz Mercedes Benz Mercedes Benz Mercedes Benz Mercedes Benz Mercedes Benz Mercedes Benz Mercedes Benz Mercedes Benz Mercedes Benz Mercedes Benz Kögel Mercedes Benz Jost	430	45	211	132,5	238	M14x1,5	37	10

① Zie pagina 23

② De originele onderdeelnummers dienen alleen voor vergelijkingsdoeleinden en identificatie.







## Remschijven

	Onderdeelnummer ①	Ref. Nr. OEM ②	Toepassing	A	B	C	H	D	Ø N	X	Aantal gaten
	S0790331200	A9434210312 A9434210412 A9434210512	Mercedes Benz	430	45	199	143	168	21	37	10
	S0790331220	A9754230012 A9754230312 A9754230612 A6754230312	Mercedes Benz	377	45	176	138,5	201	M14x1,5	37	8
	S0790341200	A9604210312 A9604210412 A9604210512	Mercedes Benz	430	45	131	131,5	168	21	37	10
	S0790361210	A9704210112 A9704210212 A9704210612 A9704210012 A9704210712 A638421011205	Mercedes Benz	335	34	146	90,5	120	M14x1,5	28	10
	S0790361220	A9704230412 A9704230612 A9704230312 A9704231212	Mercedes Benz	335	34	145	111	177	M12x1,5	28	8
	S0790419100	082135830 000234110 082133300 1131025 501315228 1415146 1415147 36508030000 0501316953 A0004200272 920924972 11015508 1521148 1525365 1962280 42541277 N1011015508 A0004200172 A0004210312 072136218 080455010 1137191	Neoplan Neoplan Neoplan Volvo Neoplan Neoplan Scania MAN Mercedes Benz Neoplan Mercedes Benz Van Hool Neoplan DAF DAF DAF Iveco MAN Mercedes Benz Mercedes Benz Neoplan Neoplan DAF	430	45	203	131	235	M16x1,5	37	10

① Zie pagina 23

② De originele onderdeelnummers dienen alleen voor vergelijkingsdoeleinden en identificatie.

## Remschijven

	Onderdeelnummer ①	Ref. Nr. OEM ②	Toepassing	A	B	C	H	D	Ø N	X	Aantal gaten
	S0790446100	1906461 1906438 7182305 2992470 2996329 7179778 42557315 7192305	Iveco	436	45	210	138,5	240	M16x2	37	12
	S0790449500 (inclusief montage-set)	85103804 85110495 5001867798	Volvo Volvo Renault	409,8	45	220	45	–	–	41	–
	S0790471000 (inclusief montage-set)	3092710 8551042 21526754 7421526754	Volvo Volvo Volvo Renault	434	45	220	45	–	–	41	–
	S0790480300 (inclusief montage-set)	85103803 21575071 20428193 20515083 20515093 85110496 5001864498 7420515093 7421575117	Volvo	434	45	220	45	–	–	41	–
	S0790501400	81508030009 81508030014 81508030015 81508030001	MAN	438	45	200	135	235	M16x1,5	35	10
	S0790502410	81508030024 81508030026	MAN	330	34	135	104	158	M14x1,5	26	10
	S0790503810	81508030040 81508030023 81508030031 81508030038 81508030036 81508030046 81508030033 81508030034 81508030035	MAN	432	45	196	130	168	19	37	12

① Zie pagina 23

② De originele onderdeelnummers dienen alleen voor vergelijkingsdoeleinden en identificatie.

## Remschijven

	Onderdeelnummer ①	Ref. Nr. OEM ②	Toepassing	A	B	C	H	D	Ø N	X	Aantal gaten
	S0790504120	81508030041 81508030021 82508030041 81508033041 81508030047	MAN	432	45	208	135	235	M16x1,5	35	10
	S0790504210	81508030042 81508030053	MAN	335	34	90	93	122	14,9	30	10
	S0790505710	81508030057 81508030020 81508030027	MAN	377	45	162	128	195	M14x1,5	37	10
	S0790506300	81508030054 81508030063 81324006005 81508030062 81508030043	MAN	335	35	154	118	175	M14x1,5	28	10
	S0790627200	1367735 1386686 1402272 1852817 1889543 13866867 1402272	Scania	430	45	208	131	237	M16x1,5	37	10
	S0790713600	2992477 2996327 2996329 7184136 7189475 7079778	Iveco	432	45	210	138,5	240	M16x2	37	12
	S0790770200	2995702 2995894 2996708 7187541 7185471 7189976	Iveco	377	45	113	106,8	144	15,3	37	14

① Zie pagina 23

② De originele onderdeelnummers dienen alleen voor vergelijkingsdoeleinden en identificatie.



## Remschijven

	Onderdeelnummer ①	Ref. Nr. OEM ②	Toepassing	A	B	C	H	D	Ø N	X	Aantal gaten
	S0790772500	1907725 1907528 1907529 1908577 1907826 1907524 7173036 7182681	Iveco	304	30	165	128	205	18,1	27,5	6
	S0790772600	1907526 1907527 1907530 1907726 1908578 7172018 7172078 7182682	Iveco	322	30	215	134	275	20,15	27,5	8
	S0790781200	2995812 2996328 7185503 7189476	Iveco	432	45	210	138,5	240	M16x2	37	12
	S0790859300	5010422593 7482194787 5010216437 5010422363 5010216437 82196750 68323552 2996353	Renault Renault Renault Renault Renault Volvo MERITOR / ROR Iveco	434	45	131	96,7	165	17	41	10
	S0790934900	21227349 21225115 22227349 1109488	MERITOR/ROR MERITOR/ROR MERITOR/ROR Schmitz	378	45	222	150	250	M16x2	37	10
	S0790982500	68323825	MERITOR/ROR	434	45	222	150	250	M16x2	39	10
	S0791067010	1400163 1408252 1408670	DAF	330	34	117	123	138	M12x1,75	28	12

① Zie pagina 23

② De originele onderdeelnummers dienen alleen voor vergelijkingsdoeleinden en identificatie.

## Remschijven

	Onderdeelnummer ①	Ref. Nr. OEM ②	Toepassing	A	B	C	H	D	Ø N	X	Aantal gaten
	S0791067220	1400273 1407581 1408254 1408672	DAF	330	34	150	119	175	M12x1,75	28	12
	S0791100100	50390001	VALX	430	45	300	187,5	335	22,6	37	10
	S0791100200	50390002	VALX	375	45	300	187,5	335	22,6	37	10
	S0791208600	09267086 709267086 550012742	Gigant Gigant Krone	430	45	280	155	335	26,5	37	10
	S0791301800	M069018 103696 13162025 M200135 449445	Fruehauf	430	45	280	155	335	26,5	37	10
	S0791413300	1088133	Schmitz	375	45	290	168,5	335	22,5	37	10
	S0791487000	017870 1176816 1160124 1248264	Schmitz	430	45	290	168,5	335	22,5	37	10

## Toebehoren Integral remmen

Onderdeelnummer ①	Ref. Nr. OEM ②	Toepassing	Geschikt voor
S4340003000	03434366201 03434366200	SAF	S0790101000 S0790101300

① Zie pagina 23

② De originele onderdeelnummers dienen alleen voor vergelijkingsdoeleinden en identificatie.



[www.sauer-qualityparts.com](http://www.sauer-qualityparts.com)



## REMTROMMELS

Truck en Trailer onderdelen

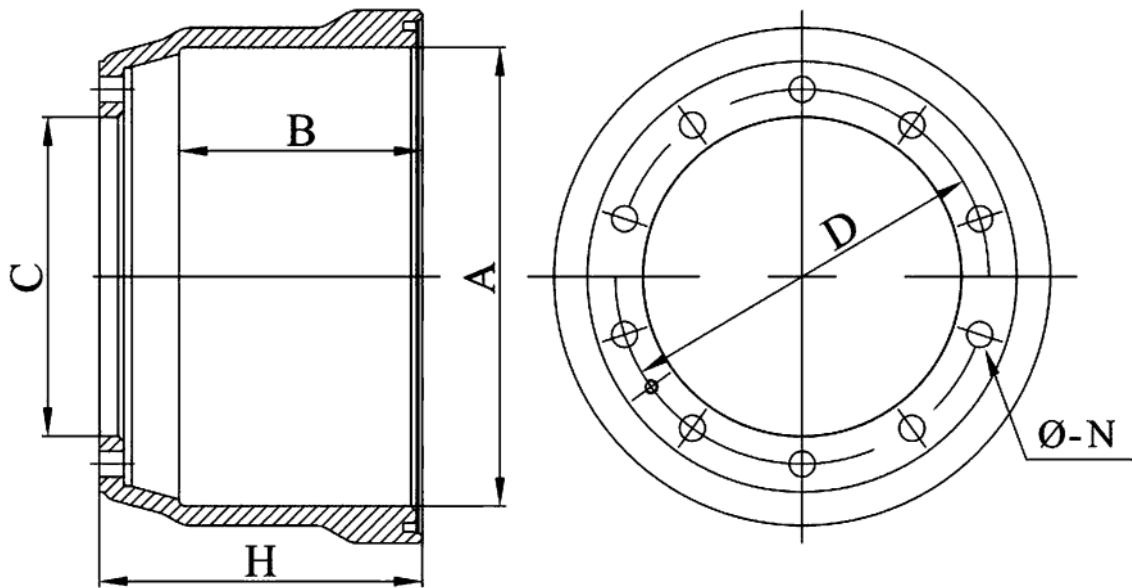

## Remtrommels

	Onderdeelnummer ①	Ref. Nr. OEM ②	Toepassing	A	B	C	H	D	Ø N	Aantal gaten
	S0640119700	01064019700	SAF	300	212,5	190	280	225	23	10
	S0640126000	01064026001 01064026002	SAF	420	195	300	226,5	335	23	10
	S0640127000	01064027000 1004661	SAF Schmitz	420	219	300	255,5	335	23	10
	S0640127300	550002237 01064027300 1044330	Krone SAF Schmitz	300	212	190	280	225	23	10
	S0640203000	0310990030	BPW	360,2	200,5	230	260	275	23	8
	S0640206000	0310946060 0310946070	BPW	300,2	210	190	260	225	23	10
	S0640216000	0310977160 0310977570 0310977770 012266 018083	BPW BPW BPW Schmitz Schmitz	420	215	290	260	335	23	10
	S0640217000	0310977170 0310977420 0310977330	BPW	420,2	215	290	259,5	335	23	10
	S0640218000	0310977180 0310977230 0310977430	BPW	420,2	225	290	285	335	23	10
	S0640219000	0310967190 0310967290 0310967790 0910967790 550015680 5021202644	BPW BPW BPW BPW Krone Renault	420,2	191,5	290	226	335	23	10

① Zie pagina 33

② De originele onderdeelnummers dienen alleen voor vergelijkingsdoeleinden en identificatie.

① Dit zijn SAUER QUALITY PARTS onderdeelnummers. Het zijn geen originele OEM of OEM geautoriseerde producten, maar het is een Aftermarket product.

## Remtrommels

	Onderdeelnummer ①	Ref. Nr. OEM ②	Toepassing	A	B	C	H	D	Ø N	Aantal gaten
	S0640222000	0310990220 0310590020	BPW	360	209	230	263	275	23	8
	S0640249000	0310546290 0310946490	BPW	300	210,5	190	260	225	23	10
	S0640262000	0310667620 0310967820 0310967130	BPW	420	194	290	230	335	23	10
	S0640300110	A6584210001 A6864210001 A6244210201	Mercedes Benz	410	191	298	237	335	23	10
	S0640327110	A3874210201 A6584210301	Mercedes Benz	410	192,5	298	260	335	23	10
	S0640340110	A3054210401 A3054210101 A3054210001 A3054230601 A3564210001	Mercedes Benz	410	167	298	213	335	23	10
	S0640340120	81501100122 A3054230201 A3054230301 A3054230401 A3054230701 A3554230301	MAN Mercedes Benz Mercedes Benz Mercedes Benz Mercedes Benz Mercedes Benz	410	238	298	306	335	23	10
	S0640401200	1599012	Volvo	410	231,5	282	410	231,5	282	10
	S0640430600	7421451969 1075306 1599009 21094122 21451966 3171744	Renault Volvo Volvo Volvo Volvo Volvo	410	199	282	260	335	28	10

① Zie pagina 33

② De originele onderdeelnummers dienen alleen voor vergelijkingsdoeleinden en identificatie.

## Remtrommels

	Onderdeelnummer ①	Ref. Nr. OEM ②	Toepassing	A	B	C	H	D	Ø N	Aantal gaten
	S0640430900	7420713927 7421359819 7421451973 1075309 21094123 21451967 21508812 31508812 3171747	Renault Renault Renault Volvo Volvo Volvo Volvo Volvo Volvo	410	218	282	294	335	28	10
	S0640431320	1590313 1134818	Volvo	394	266	282	314	335	28	10
	S0640481710	1134817	Volvo	394	218	282	269	335	28	10
	S0640514400	81501100144 81501100107 81501100104 81501100200 81501100245 81501100244 64501100002	MAN	410	232	298	300	335	23	10
	S0640521310	81501100213 81501100118 81501100242	MAN	410	172	298	250	335	23	10
	S0640523200	81501100232 81501100227 81501100214 81501100239	MAN	410	188	298	232	335	23	10
	S0640615200	1414152 1334075 392391	Scania	413	189	295	263	335	23,5	10
	S0640633110	1414153 1361331 392386 1333117 1381331 360571 2109552 2378715	Scania	413	213	295	275	335	23,5	10

① Zie pagina 33

② De originele onderdeelnummers dienen alleen voor vergelijkingsdoeleinden en identificatie.

## Remtrommels







	Onderdeelnummer ①	Ref. Nr. OEM ②	Toepassing	A	B	C	H	D	Ø N	Aantal gaten
	S0640643500	1414435 1385893 293543 360573 305438 342880 2109553 2378716	Scania	413	266	295	321	335	23,5	10
	S0640705000	7183050	Iveco	410	213	285	290	335	23	10
	S0640742700	42118427 42102583	Iveco	410	211	285	282	335	23	10
	S0640876800	5000737768 5010019220	Renault	414	182	280,8	230	335	25	10
	S0640894900	5010098949 5001019218	Renault	414	232	280,8	278	335	26,5	10
	S0640911400	21021114AV 21023064 21020038 21021164	MERITOR/ROR	419,1	230	283	272	335	24,5	10
	S0640918300	21219028 21220183AV 22222978 22224179 21223852	MERITOR/ROR	419	188	283	238	335	24,25	10
	S0640996300	21018963 21209723S 21023036	MERITOR/ROR	311	202	183	260	225	24,25	10
	S0640998600	21018986V 21021163 21021284	MERITOR/ROR	419	199	283	248	335	24,5	10

① Zie pagina 33

② De originele onderdeelnummers dienen alleen voor vergelijkingsdoeleinden en identificatie.



## Remtrommels

	Onderdeelnummer ①	Ref. Nr. OEM ②	Toepassing	A	B	C	H	D	Ø N	Aantal gaten
	S0641039700	754397 075983	DAF	420	213	285	287,5	335	24	10
	S0641046200	1233462 595225 94903 284620	DAF	420	163	285	230	335	24	10
	S0641080600	1232806 275824 90498	DAF	420	192	285	251	335	24	10
	S0641239700	730397 7303097 Y00000227	SAE/Gigant	305	210	175,8	284	225	26,5	10
	S0641300200	1030341 AJB0465001 M003176 7000085S 449628 AJB0465002	SMB/Fruehauf	419	215	288	256	335	26,5	10
	S0641503700	1008 09380037 709380037 Y00006429 YO11004098	SAE/Gigant	300	205	180	260	225	26,5	10
	S0641516000	790160 Y11000251	SAE/Gigant	305	210	175,8	256,5	225	26,5	10

① Zie pagina 33

② De originele onderdeelnummers dienen alleen voor vergelijkingsdoeleinden en identificatie.





[www.sauer-qualityparts.com](http://www.sauer-qualityparts.com)



## LUCHTBALGEN

Truck en Trailer onderdelen

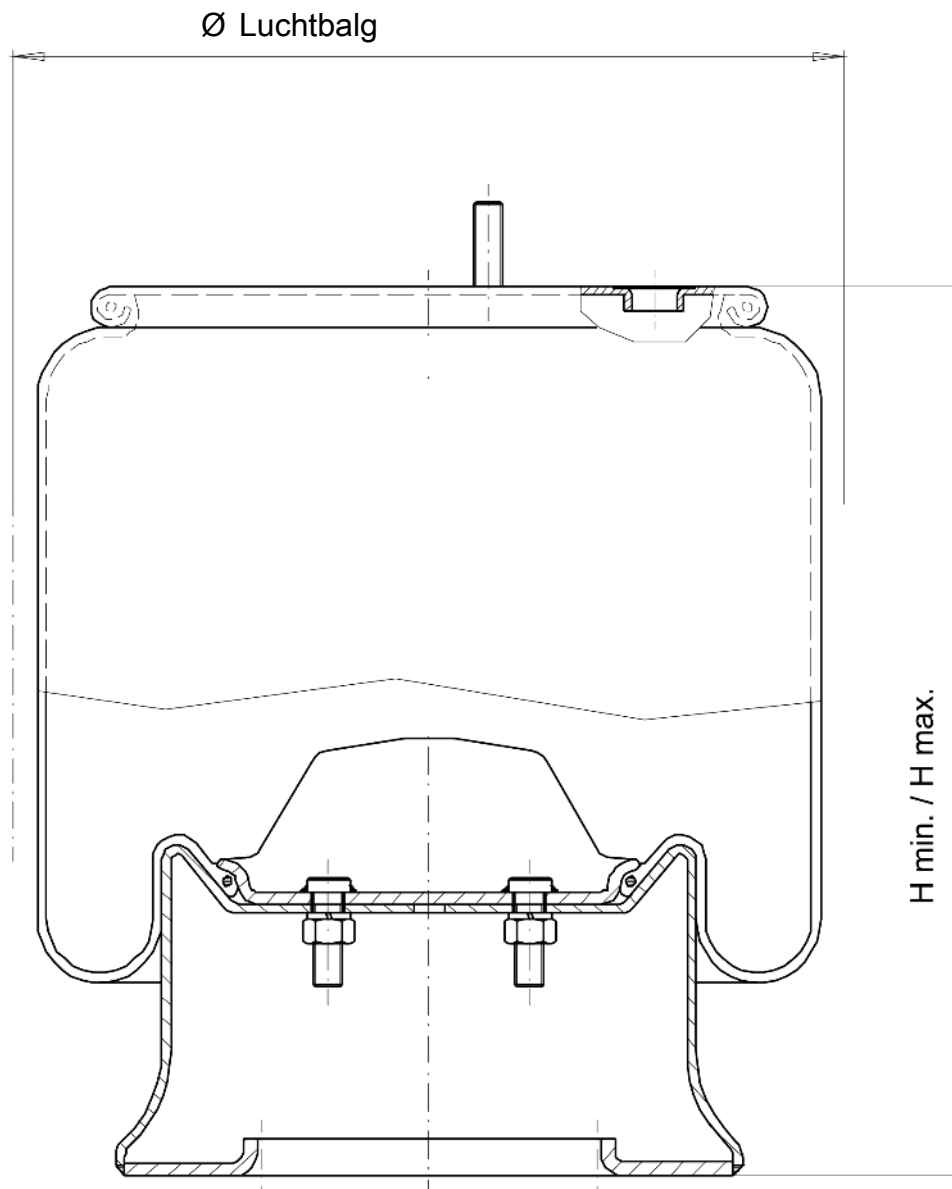

A	Aluminium	K	Met topplaat
M	Metaal / Staal	O	Zonder onderpot
P	Kunststof		

De uiteindelijke afmetingen van de luchtbalgen zijn afhankelijk van het productieproces van de fabriek.

## Truck

Onderdeelnummer ①	Ref. Nr. OEM ②	Toepassing	Ref. Nr. Conti ②	Onderpot	Ø Luchtbalg	H min./ H max.	Slag
S2290720000	0220024100 81436010033 81436010036 81436010037 A3873280101 100112300 1590136 1622115 1629193	BPW MAN MAN MAN Mercedes Benz Neoplan Volvo Volvo Volvo	720N	O	240	–	–
S2290836100	0067504	DAF	836M	K	265	–	–
S2290836301	0388165 0388166 1529833 1697678 0285859 0285860	DAF	836MK1	M	265	107 / 485	378
S2290882000	81436010065 81436010067 81436010070 81436010092 81436010099 81436010103 81436010121 81436010132 A6583280101 A6993280101	MAN MAN MAN MAN MAN MAN MAN MAN Mercedes Benz Mercedes Benz	882N1	O	210	–	–
S2290887301	0392011 0392022 1529834 1697684	DAF	887MK1	M	283	180 / 590	410
S2291857300	20909150 21977973	Volvo	6630NP01	M	228	250 / 560	310

① Zie pagina 41

② De originele onderdeelnummers dienen alleen voor vergelijkingsdoeleinden en identificatie.

## Truck

Onderdeelnummer ①	Ref. Nr. OEM ②	Toepassing	Ref. Nr. Conti ②	Onderpot	Ø Luchtbalg	H min./ H max.	Slag
S2291885001	1519066	DAF	1885N1	O	230	-	-
	42534924	Iveco					
	5000301452	Iveco					
	98478799	Iveco					
	81436010069	MAN					
	81436010104	MAN					
	81436010108	MAN					
	81436010109	MAN					
	81436010111	MAN					
	81436010120	MAN					
	81436010123	MAN					
	81436010125	MAN					
	81436010130	MAN					
	81436010134	MAN					
	81436010140	MAN					
	81436010146	MAN					
	81436010147	MAN					
81436010150	MAN						
A6583280001	Mercedes Benz						
S2291888000	81436010163	MAN	1888N	O	243	-	-
	81436010162						
S2294162201	JAE3010502501 JAS3010502501 A9463282501	Jost Jost Mercedes	4162NP01	P	315	225 / 575	350
S2294183326	A9423202321 A9423206921 A9423201421 A9423200557	Mercedes Benz	4183NP28	M	300	185 / 635	450
S2294390321	A9423200121 A9423202821 A9423204921	Mercedes Benz	4390NP01 / NP21	M	266	185 / 585	400
S2294390322	A9423200221 A9423202921 A9423205021 A9423205051	Mercedes Benz	4390NP02 / NP22	M	266	185 / 585	400
S2294390323	A9423200421 A9423205221	Mercedes Benz	4390NP03 / NP23	M	300	190 / 610	420
S2294561302	22058738 21224746	Volvo	4561NP02	M	320	160/520	360
S2294571302	22056630 21224750	Volvo	4571NP02	M	290	185/560	375
S2294705101	81436010155 81436010668	MAN	4705N1P01	K	265	-	-

① Zie pagina 41

② De originele onderdeelnummers dienen alleen voor vergelijkingsdoeleinden en identificatie.

## Truck

Onderdeelnummer ①	Ref. Nr. OEM ②	Toepassing	Ref. Nr. Conti ②	Onderpot	Ø Luchtbalg	H min./ H max.	Slag
S2294705303	81436006039	MAN	4705N1P03	M	265	210 / 660	450
S2294713104	1076595 8158106	Volvo	4713NP04	K	290	–	–
S2294713302	1076594 20554755	Volvo	4713NP02	M	290	240 / 570	330
S2294757321	A9423204321 A9423200117 A9423270101	Mercedes Benz	4757NP21	M	260	180 / 575	395
S2294757329	9423203221 9743200217 9743200417	Mercedes Benz	4757NP29	M	260	180 / 575	395
S2294760300	20554760 20580705 20479800 21961472 20452142	Volvo	6612NP01	M	295	250 / 598	348
S2294786321	A9423204521 A9743200117 A9463200421 A9743200017	Mercedes Benz	4786NP21	M	236	155 / 425	270
S2294838321	A9423203821 A9463200421	Mercedes Benz	4838NP21	M	255	235 / 790	555
S2294838322	A9423203621 A9463200221	Mercedes Benz	4838NP22	M	330	280 / 790	510
S2294882101	81436010151 81436010176 81436016065	MAN	4882N1P01	K	225	–	–
S2294882305	81436006036 81436006056	MAN	4882N1P05	M	225	205 / 600	395
S2294884101	81436010152 81436010174 81436010175 81436016066	MAN	4884N1P01	K	240	210 / 600	390
S2294884306	81436006035 81436006055	MAN	4884N1P06	M	235	210/830	620
S2294912307	5010294307 5010239213 5001832067	Renault	4912NP07	M	410	250/795	545

① Zie pagina 41

② De originele onderdeelnummers dienen alleen voor vergelijkingsdoeleinden en identificatie.

## Truck

Onderdeelnummer ①	Ref. Nr. OEM ②	Toepassing	Ref. Nr. Conti ②	Onderpot	Ø Luchtbalg	H min./ H max.	Slag
S2294912310	5010557355 7422025556 20722412 22025568	Renault Renault Volvo Volvo	4912NP10	M	317	250/795	545
S2294913302	1379392 1379393 1440294 1510195 1543691 1731113 1422750 543691	Scania	4913NP02	M	323	235 / 770	535
S2294930200	1434930 1932592 2617884	Scania	–	P	270	215 / 655	440
S2294933300	1434933 1932593 2617887	Scania	–	M	340	215 / 635	420
S2296122246	A9603207021 A9603200057 A9603206757	Mercedes Benz	6122NP46	P	200	185/660	475
S2296200300	1362147 1370744 1386200	Scania	6701NP01	M	355	264 / 641	377
S2296251200	1314903 1394997 1402423 1865759	Scania	6705NP01	M	–	160 / 460	300
S2296339300	W01M56339	Firestone	–	M	265	215 / 645	430
S2296416100	7422071639 1075891 1076416 20374510 20456152 20531985 20582215 21961456 70321693	Renault Volvo Volvo Volvo Volvo Volvo Volvo Volvo Volvo	6416N / 6608NP01	K	248	–	–

① Zie pagina 41

② De originele onderdeelnummers dienen alleen voor vergelijkingsdoeleinden en identificatie.



## Truck

Onderdeelnummer ①	Ref. Nr. OEM ②	Toepassing	Ref. Nr. Conti ②	Onderpot	Ø Luchtbalg	H min./ H max.	Slag
S2296416300	7422071639 1075891 1076416 20374510 20456152 20531985 20582215 21961456 70321693	Renault Volvo Volvo Volvo Volvo Volvo Volvo Volvo Volvo	6416N / 6608NP01	M	248	210 / 555	345
S2296418100	1076418 3171695 20374511 20531987 20582214 20456156 21961451 70321695	Volvo	6418N / 6607NP01	K	240	–	–
S2296418300	1076418 3171695 20374511 20531987 20582214 20456156 21961451 70321695	Volvo	6418N / 6607NP01	M	240	188 / 644	456
S2296420300	3171694 20375227 20427801 20427804 20456154 20531986 20582209 21961443 70321694 20427805	Volvo	6420N / 6606NP01	M	272	180 / 500	320
S2296700302	1774804 1903608 1944314 2357460 2357532 2198915	Scania	6700NP02	M	315	210 / 805	595

① Zie pagina 41

② De originele onderdeelnummers dienen alleen voor vergelijkingsdoeleinden en identificatie.

## Truck

Onderdeelnummer ①	Ref. Nr. OEM ②	Toepassing	Ref. Nr. Conti ②	Onderpot	Ø Luchtbalg	H min./ H max.	Slag
S2297803300	7422071638 1075890 1076415 20375226 20427800 20427803 20456150 20531984 20582206 21961374 3171692	Renault Volvo Volvo Volvo Volvo Volvo Volvo Volvo Volvo Volvo Volvo	7803N / 6605NP01	M	248	185 / 585	400
S2297803100	7422071638 1075890 1076415 20375226 20427800 20427803 20456150 20531984 20582206 21961374 3171692	Renault Volvo Volvo Volvo Volvo Volvo Volvo Volvo Volvo Volvo Volvo	7803N / 6605NP01	K	248	–	–
S2299270300	M3542 S20010 1003589270C 85101147 AS0084	Brake & Wheel Hendrickson Ridwell Volvo Watson & Chalin	–	M	254	115 / 651	536

① Zie pagina 41

② De originele onderdeelnummers dienen alleen voor vergelijkingsdoeleinden en identificatie.

## Trailer

Onderdeelnummer ①	Ref. Nr. OEM ②	Toepassing	Ref. Nr. Conti ②	Onderpot	Ø Luchtbalg	H min./ H max.	Slag
S2290081300	HS2500915 HS251087 A9463280401 5010557164 2500915	Hendrickson Hendrickson Mercedes Benz Renault SAMRO	–	M	333	200 / 550	350
S2290725302	166217	Gigant	725NP02	M	300	249 / 700	451
S2290725303	166252	Gigant	725NP03	M	300	255 / 705	450
S2290752300	247100 700247100	SAE / Gigant	752NP01	M	300	357 / 948	591
S2290810300	1322719 1384273 15635 506243 785168 12108082 21208032 21208082 21215632 5000452939 5021170405 02229000200 1723502 6504646G HB10315 1080707 US00622 US07337 US087413 US0874131	DAF DAF Granning Hendrickson Hendrickson MERITOR / ROR MERITOR / ROR MERITOR / ROR MERITOR / ROR Renault Renault SAF Scania Trailor Trouillet Volvo Weweler Weweler Weweler Weweler	810MB	M	265	188 / 525	337

① Zie pagina 41

② De originele onderdeelnummers dienen alleen voor vergelijkingsdoeleinden en identificatie.

## Trailer

Onderdeelnummer ①	Ref. Nr. OEM ②	Toepassing	Ref. Nr. Conti ②	Onderpot	Ø Luchtbalg	H min./ H max.	Slag
S2290813300	388491 505859 785170 4731030000 4731033000 21215633 21215633 P2700MB0813 175005 5000790692 5010130925 8403102 02229000300 02229240300 02229260300 1723269 91687700000 0036158E 65023482 ST225675 128147122 644285 US07345 US87408	DAF Hendrickson Hendrickson Kässbohrer Kässbohrer MERITOR/ROR Neway PaulNFZ Pegaso Renault Renault SAE SAF SAF SAF Scania Titan Trailor Trailor Trouillet Viberti Viberti Weweler Weweler	813MB	M	265	230 / 640	410
S2290881100	0542940010 0542940081 0542942580 2338883 750228	BPW BPW BPW Scania Schmitz	881MB	K	352	–	–
S2290881200	0542943510 6AB80030100 2198330 750496 751549 FAG0410118	BPW Hüffermann Scania Schmitz Schmitz Schmitz	881MBP30	P	352	260 / 690	430
S2290881300	0542940081 0542941361 0542940540 0542941471 0542940020 0542940071 0542940391 0542940501	BPW	881MB	M	352	270 / 684	414
S2290912301	6500463 03228003000 03229003000 US07380 US07385	Kögel SAF SAF Weweler Weweler	912NP01	M	320	260 / 795	535

① Zie pagina 41

② De originele onderdeelnummers dienen alleen voor vergelijkingsdoeleinden en identificatie.

## Trailer

Onderdeelnummer ①	Ref. Nr. OEM ②	Toepassing	Ref. Nr. Conti ②	Onderpot	Ø Luchtbalg	H min./ H max.	Slag
S2290912302	507782 21222673 03229000501 03229001300 US96681	Hendrickson MERITOR / ROR SAF SAF Weweler	912NP02	M	265	273 / 765	492
S2290940100	0542940910 0542941290 0542941510 0542942560 0542942600 2406164 013769	BPW BPW BPW BPW Scania Schmitz	940MB	K	248	–	–
S2290940200	0542943210 0542943650 2198483 017331 751084 US510030UD	BPW BPW Scania Schmitz Schmitz Weweler	940MBP30	P	248	230 / 595	365
S2290941100	0542940030 0542942570 015514	BPW BPW Schmitz	941 MB	K	288	–	–
S2290941200	0542943200 2338887 015502 017109	BPW Scania Schmitz Schmitz	941MBP30	P	300	250 / 705	455
S2290942100	0542940050 81440500142 017199	BPW MAN Schmitz	942MB	K	356	–	–
S2290942300	0542940050 0542940580 0542941690 81440500142 017199	BPW BPW BPW MAN Schmitz	942MB	M	311	240 / 810	570
S2291285100	017089 017685 US04029P US04031P	Schmitz Schmitz Weweler Weweler	–	K	265	–	–
S2291285301	2198324 017089 017685 US04029P US04031P	Scania Schmitz Schmitz Weweler Weweler	–	M	265	250 / 640	390
S2291847300	HS508263 A9423205921	Hendrickson Mercedes Benz	–	M	248	220 / 510	290

① Zie pagina 41

② De originele onderdeelnummers dienen alleen voor vergelijkingsdoeleinden en identificatie.

## Trailer

Onderdeelnummer ①	Ref. Nr. OEM ②	Toepassing	Ref. Nr. Conti ②	Onderpot	Ø Luchtbalg	H min./ H max.	Slag
S2292626200	360112 03229003900	Kögel SAF	–	P	258	265 / 600	335
S2292813300	JAE2010501901 A9463281901 US07337RP	Jost Mercedes Benz Weweler	–	M	333	215 / 525	310
S2292828200	1111841 1336402	Schmitz	–	P	259	219 / 732	513
S2292851200	1077929 1336404	Schmitz	–	P	248	210/728	518
S2292919200	03229004200 03228004200 03228104200	SAF	–	P	265	213 / 543	330
S2292923200	03228102801 03229002800 1723276 1873863	SAF SAF Scania Scania	–	P	323	240 / 540	300
S2292924200	6300123 03229004100	Kögel SAF	–	P	350	240 / 640	400
S2293042301	3042B 166292 166362 247104 700247104	Gigant	724K	M	248	250 / 580	330
S2293138100	04284300400	SAF	3138NP01	K	300	–	–
S2294004203	03229000702 1723273 012795	SAF Scania Schmitz	4004NP03	P	288	185 / 525	340
S2294008301	UJB0305001 21221349 03229002400 H2500361 1873856 US07380	Fruehauf Meritor/ROR SAF Samro Scania Weweler	4008NP01	M	324	257 / 670	413
S2294022100	04284300600	SAF	–	K	258	–	–
S2294022203	03229002900 1723277 751328	SAF Scania Schmitz	4022NP03	P	258	210 / 540	330
S2294022205	03229003300 1723281 751443	SAF Scania Schmitz	4022NP05	P	258	185 / 540	355

① Zie pagina 41

② De originele onderdeelnummers dienen alleen voor vergelijkingsdoeleinden en identificatie.

## Trailer

Onderdeelnummer ①	Ref. Nr. OEM ②	Toepassing	Ref. Nr. Conti ②	Onderpot	Ø Luchtbalg	H min./ H max.	Slag
S2294023303	336076 03229003100 1723280 751082	Kögel SAF Scania Schmitz	4023NP03	M	318	230 / 670	440
S2294156215	M001472 HA100001 21215761 UJB0207 US35864F	Fruehauf Hendrickson Meritor/ROR SMB Weweler	4156NP15	P	306	239 / 516	277
S2294157204	JAE3010501401 A9463281401 21221307 US06287 US07364	Jost Mercedes Benz MERITOR/ROR Weweler Weweler	4157NP04 / NP14	P	281	225 / 575	350
S2294157205	US07074P US07074C US08840	Weweler	4157NP05	P	281	225 / 575	350
S2294157206	2198333 751065 US06316	Scania Schmitz Weweler	4157NP06	P	281	250 / 600	350
S2294157209	21222442 US07074F	Meritor/ROR Weweler	4157NP09	P	283	225 / 575	350
S2294157210	128140028 800449526 441901 UJB0975 M060924 M060924	Acerbi Acerbi Fruehauf Fruehauf Gigant SMB	4157NP10	P	283	225 / 575	350
S2294158102	750599 US06285	Schmitz Weweler	4158NP02	K	282	–	–
S2294158203	03229264300 2198334 041892 750999 US06285	SAF Scania Schmitz Schmitz Weweler	4158NP03	P	282	258 / 657	399
S2294159105	1525199 UJY0099 UJB0358 M001774	Fruehauf	4159NP05	K	310	–	–

① Zie pagina 41

② De originele onderdeelnummers dienen alleen voor vergelijkingsdoeleinden en identificatie.

## Trailer

Onderdeelnummer ①	Ref. Nr. OEM ②	Toepassing	Ref. Nr. Conti ②	Onderpot	Ø Luchtbalg	H min./ H max.	Slag
S2294159209	58051210 UJA09030 UJB0358001 H2500324 1525199 M001774	Cardi Fruehauf Fruehauf SAMRO SMB SMB	4159NP09	P	310	252 / 650	398
S2294159307	UJA0894 UJB0203001 1518779 1520356 1524873 M001782	Fruehauf Fruehauf SMB SMB SMB SMB	4159NP07	M	–	–	–
S2294810305	03228102700 03229002700 03229212700 03229222700 1723275 016010 1101440 750856	SAF SAF SAF SAF Scania Schmitz Schmitz Schmitz	4810NP05	M	405	210 / 590	380
S2294823300	JAE2010501501 A9463281501 017924 1288087 1344510 FAG0410087 US04030G US4030P	Jost Mercedes Benz Schmitz Schmitz Schmitz Schmitz Weweler Weweler	4035NP02	M	322	237 / 639	402
S2294881102	0542941010 0542941221 0542941311 750570	BPW BPW BPW Schmitz	4881NP02	K	352	–	–
S2294881230	0542943390 0542943410 0542943440 2198331 750491 751356	BPW BPW BPW Scania Schmitz Schmitz	4881NP30	P	352	230 / 550	320
S2294881300	0542941221 0542941311 0542941031	BPW	4881MB	M	352	230 / 550	320
S2294942102	0542941090	BPW	4942NP02	K	300	–	–
S2294960200	0542943230	BPW	4960MB	P	248	200 / 545	345

① Zie pagina 41

② De originele onderdeelnummers dienen alleen voor vergelijkingsdoeleinden en identificatie.



## Trailer

Onderdeelnummer ①	Ref. Nr. OEM ②	Toepassing	Ref. Nr. Conti ②	Onderpot	Ø Luchtbalg	H min./ H max.	Slag
S2296318100	016512 US06318F	Schmitz Weweler	–	K	290	–	–
S2296318200	016512 016588 1103345 1244666 188112 US06318F US86318F	Schmitz Schmitz Schmitz Schmitz Schmitz Weweler Weweler	–	P	290	185 / 485	300
S2296318202	1274268 1371342 YP06318SF	Schmitz Schmitz Weweler	–	P	290	185 / 485	300
S2298540200	09377011 09377011 80130002 US04200BF US04200BP YP4200WBW	SAE SMB VALX Weweler Weweler Weweler	–	P	250	175 / 600	425
S2298608200	052360 CF154091 21229214	Bevola Fruehauf MERITOR / ROR	–	P	287	240 / 565	325

① Zie pagina 41

② De originele onderdeelnummers dienen alleen voor vergelijkingsdoeleinden en identificatie.

## Bus

Onderdeelnummer ①	Ref. Nr. OEM ②	Toepassing	Ref. Nr. Conti ②	Onderpot	Ø Luchtbalg	H min./ H max.	Slag
S2290301300	1440301 1440856 488265 470920	Scania	–	M	248	159 / 388	229
S2290302300	1440302 1140857 470921 488266	Scania	–	M	248	180 / 450	270
S2290302301	1726238	Scania	6708NP02	M	235	187 / 519	332
S2290304300	1440304 470922	Scania	–	M	235	225 / 580	355
S2290305300	1440305 1440859 473868 492680	Scania	–	M	235	227 / 589	362
S2290305301	1726241	Scania	6710NP04	M	235	227 / 549	332
S2290307301	1726246	Scania	6711NP02	M	230	190 / 420	230

① Zie pagina 41

② De originele onderdeelnummers dienen alleen voor vergelijkingsdoeleinden en identificatie.

## Bus

Onderdeel- nummer ①	Ref. Nr. OEM ②	Toepassing	Ref. Nr. Conti ②	Onderpot	Ø Luchtbalg	H min./ H max.	Slag
S2290644000	0220024400	BPW	644N	O	284	-	-
	199196	Breda Menarini					
	536905265	Buessing					
	536905266	Buessing					
	96708659	Daewoo					
	1322713	DAF					
	689677	DAF					
	A0003200321	EvoBus					
	A0003270101	EvoBus					
	A0003270201	EvoBus					
	A3073280001	EvoBus					
	546905134	Hanomag					
	4771143000	Kässbohrer					
	4771170000	Kässbohrer					
	4771170000	Kässbohrer					
	4771441000	Kässbohrer					
	81436010017	MAN					
	90831120144	MAN					
	A6133270001	Mercede Benz					
	A0003270101	Mercedes Benz					
	A3023270001	Mercedes Benz					
	A3273270001	Mercedes Benz					
	A3273270101	Mercedes Benz					
	A3273280001	Mercedes Benz					
	A3643277001	Mercedes Benz					
	100110300	Neoplan					
	100112254	Neoplan					
AA1001300	Neoplan						
624319420	Van Hool						
624319610	Van Hool						
689677	VDL Bus						
1134445	Volvo						
1199893	Volvo						
1622111	Volvo						

① Zie pagina 41

② De originele onderdeelnummers dienen alleen voor vergelijkingsdoeleinden en identificatie.

## Bus

Onderdeelnummer ①	Ref. Nr. OEM ②	Toepassing	Ref. Nr. Conti ②	Onderpot	Ø Luchtbalg	H min./ H max.	Slag
S2290661000	546905134 831120144 A4103270001 536905265 41822247 4746733 5001829866 4731012000 4731031000 4731042000 4771427000 4771440000 02498667 90831120144 100112250 11016345 AA1001001 750208 624319670 624319690 624319700 1137888 3195253	Buessing Buessing Evobus Hanomag Iveco Iveco Iveco / Irisbus Kässbohrer Kässbohrer Kässbohrer Kässbohrer Kässbohrer Magirus-Deutz MAN Neoplan Neoplan Neoplan Schmitz Van Hool Van Hool Van Hool Volvo Volvo	661N	O	240	-	-
S2290916001	81436010095 81436010097 81436010100 81436010102 81436010105 81436010126 81436010138 81436010143 L5820005 TE771107Y 1770000160	MAN MAN MAN MAN MAN MAN MAN MAN Optare Tems ZF Sachs	916N1 916N6 916N5	O	268	-	-
S2290720000	0220024100 81436010033 81436010036 81436010037 A3873280101 100112300 1590136 1622115 1629193	BPW MAN MAN MAN Mercedes Benz Neoplan Volvo Volvo Volvo	720N	O	240	-	-
S2290836100	0067504	DAF	836M	K	265	-	-

① Zie pagina 41

② De originele onderdeelnummers dienen alleen voor vergelijkingsdoeleinden en identificatie.

## Luchtbalg voor aslift

Onderdeelnummer ①	Ref. Nr. OEM ②	Toepassing	Ref. Nr. Goodyear ②	Kronkels	Montage	Luchtaansluiting
S4292211003	–	–	2B9269	2	Gewindeloch M8x1,25	1/4"
S4292211201	15603 JAE2010701601 A9463280701 A9463281601 A9463282101 21221395 21222663 016793 US06910F	Granning Jost Mercedes Benz Mercedes Benz Mercedes Benz MERITOR / ROR MERITOR / ROR Schmitz Weweler	2B9223	2	Gewindeloch M10x1.5	1/4"
S4292211211	A06030604 6501706 04299100400 1319761 1387283 1387289 1723523 1863244	Granning Kögel SAF Scania Scania Scania Scania Scania	2B9700	2	Gewindeloch M10x1.5	M12x1,5
S4292302301	881202 15813 USN510011KD	Gigant Granning Weweler	2B122452	2	Bolzen M10x1.5	1/2"
S4292304302	UJB0985 15814 A06030601 M063796	Fruehauf Granning Lohr SMB	2B122457	2	Bolzen M10x1.5	M16x1,5
S4292305301	A06030622 M078246	Lohr SMB	2B122450	2	Bolzen M10x1.5	M16x1,5
S4293304302	881204 15816	Gigant Granning	3B122452	3	Bolzen M10x1.5	1/2"
S4293304303	A06030606 H2500011 M002297	Lohr Samro SMB	3B122455	3	Bolzen M10x1.5	M16x1,5

① Zie pagina 41

② De originele onderdeelnummers dienen alleen voor vergelijkingsdoeleinden en identificatie.

## Cabinebalg

Onderdeelnummer ①	Ref. Nr. OEM ②	Toepassing	Ref. Nr. Sachs ②	Ø Luchtbalg	H min./ H max.	Slag
S3291201300	1381919 1476415	Scania	314646	–	–	–
S3293101100	81417226048 81417226051	MAN	105855	–	–	–
S3293101200	81417226049 81417226052 81417226028	MAN	105856	–	–	–
S3293104200	81417226057 81417226075 85417226006 85417226012	MAN	135198 313183	–	–	–
S3293105200	81417226058 81417226007 85417226013 85417226024 81417226076	MAN	135200 135199 3131	–	–	–

① Zie pagina 41

② De originele onderdeelnummers dienen alleen voor vergelijkingsdoeleinden en identificatie.



[www.sauer-qualityparts.com](http://www.sauer-qualityparts.com)



## SCHOKDEMPERS

Truck en Trailer onderdelen

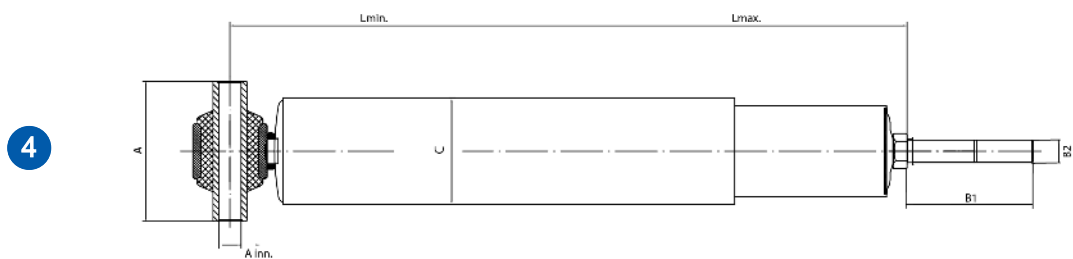
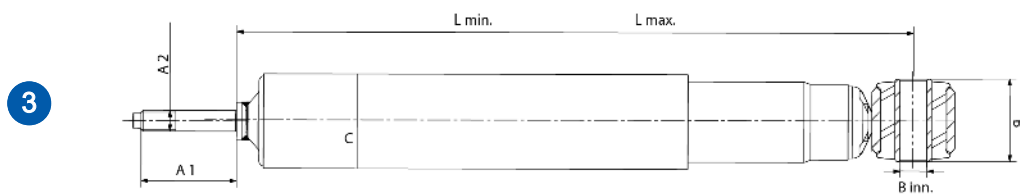
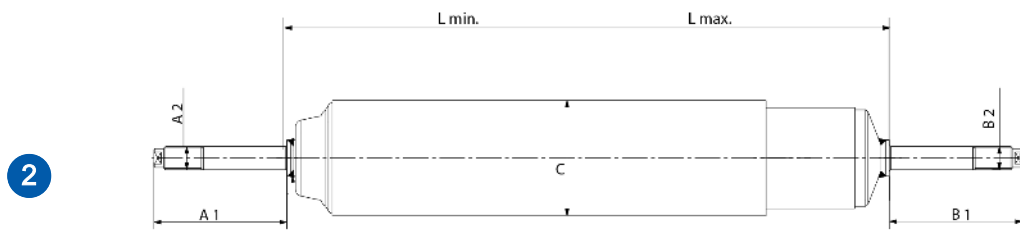
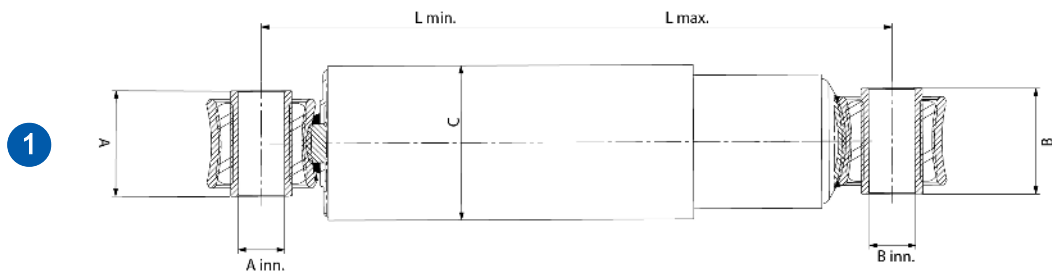

1 ... 4

Versie 1 ... 4



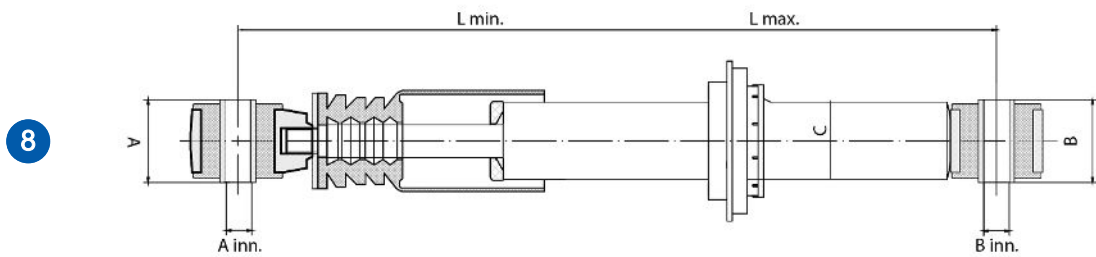
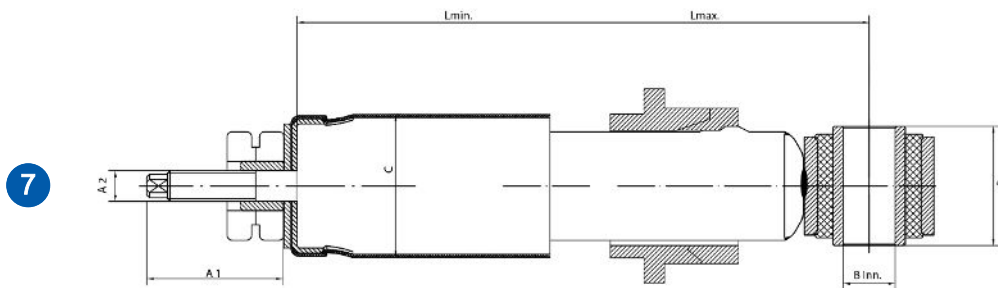
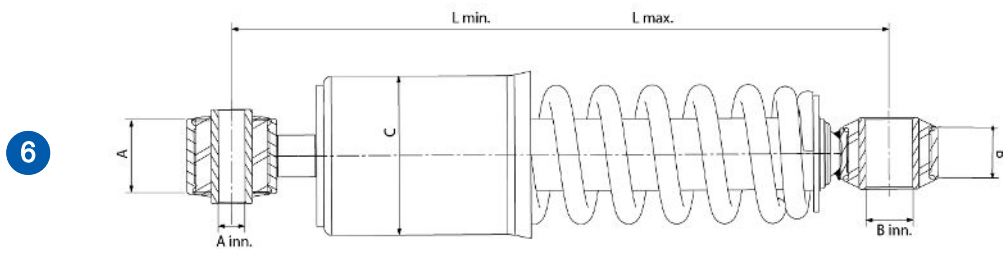
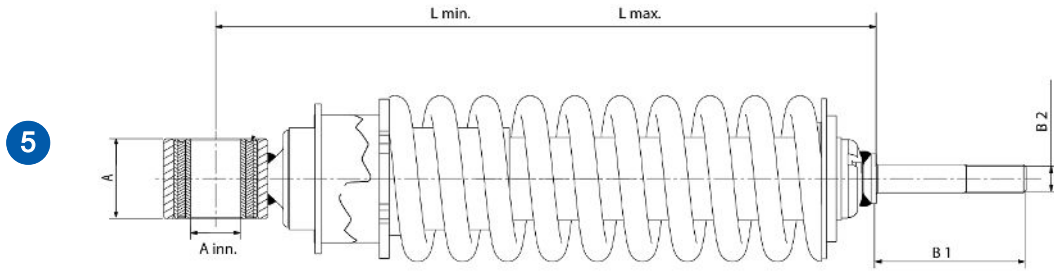







5 ... 8

Versie 5 ... 8

## Schokdempers







	Onderdeelnummer ①	Ref. Nr. OEM ②	Toepassing	Slag mm	L min. mm	L max. mm	A mm	A inn. mm	B mm	B inn. mm	C mm	A 1 mm	A 2	B 1 mm	B 2	Vers.
	S3760001000	1390898 1478501 1376430	Scania	306	431	737	-	-	50	20	63	75	M14x1.5	-	-	3
	S3760002000	1283723 296305 1205672 1211866 1283724 1283725 1283726 1283852 1286348 1327883 279245 378220 092968	DAF	250	380	630	-	-	50	20	76	75	M16x2	-	-	3
	S3760004000	0237021400	BPW	267	408	675	55	20	55	20	63	-	-	-	-	1
	S3760005000	A0063263100 A0053261100 A0063266000 A0063260100 A0053267400 A0053262500 A3753260400	Mercedes Benz	280	446	726	105	20	50	20	76	-	-	-	-	1
	S3760006000	A0053266600 A0063262400 A0063266800 A9583260700 A0053266400 A0053266000	Mercedes Benz	360	536	896	-	16	50	16	76	-	-	-	-	1
	S3760009000	6500479 02376007100 02376007101 02376007102 02376007152 017917 017919	Kögel SAF SAF SAF SAF Schmitz Schmitz	169	321	490	78	20	68	20	-	-	-	-	-	1
	S3760010000	20900497 20374545 1076717 3987957 1629478	Volvo	265	450	715	100	16	66	16	63	-	-	-	-	1

① Zie pagina 62

② De originele onderdeelnummers dienen alleen voor vergelijkingsdoeleinden en identificatie.

① Dit zijn SAUER QUALITY PARTS onderdeelnummers. Het zijn geen originele OEM of OEM geautoriseerde producten, maar het is een Aftermarket product.





## Schokdempers

	Onderdeelnummer ①	Ref. Nr. OEM ②	Toepassing	Slag mm	L min. mm	L max. mm	A mm	A inn. mm	B mm	B inn. mm	C mm	A 1 mm	A 2	B 1 mm	B 2	Vers.
	S3760011000	0083654 251700112278 81437016905 81437026062 81437026100	DAF MAN MAN MAN MAN	250	428	678	62	20	62	30	76	-	-	-	-	1
	S3760012000	5010052920 5010294413 5010383050 5010383693 5010383694 5010130401 5010383694A 5010383693A 5010294412 5010383049 2010383613 5010383692 5010557487	Renault	260	373	633	-	-	-	-	63	73	M14X1.5	75	M14X1.5	2
	S3760013000	91610269 91610272 91610274 0237022000 0237022002 0237022200 0237025100 0237025102 5180021 013506 178711204 178711207 178711209	Bartoletti Bartoletti Bartoletti BPW BPW BPW BPW BPW Lecitrailer Schmitz Viberti Viberti Viberti	260	430	690	55	24	55	24	76	-	-	-	-	1
	S3760014000	JAE301050050 361706 A9463260500	Jost Kögel Mercedes Benz	116	278	394	89	20	59	20	76	-	-	-	-	1
	S3760015000	A9428905419 A9438900319 A9428905519 A9438900119	Mercedes Benz	88	259	347	50	14	38	25	-	-	-	-	-	6
	S3760016000	1382704 1398694 1427903 1618606 1696290 1696292 1849370 1942781 1944417	DAF	292	403	695	-	-	-	-	76	75	M16x1.5	75	M16x1.5	2

① Zie pagina 62

② De originele onderdeelnummers dienen alleen voor vergelijkingsdoeleinden en identificatie.







## Schokdempers

	Onderdeelnummer ①	Ref. Nr. OEM ②	Toepassing	Slag mm	L min. mm	L max. mm	A mm	A inn. mm	B mm	B inn. mm	C mm	A 1 mm	A 2	B 1 mm	B 2	Vers.
	S3760017000	1369711 1443695 1443696 1450885 1456600 1606742 1606743	DAF	250	419	669	62	20	50	20	76	-	-	-	-	1
	S3760019000	1370093 1380423 1380425 1397523 1478507 1519631 1380427 1478509 1519633	Scania	395	555	950	50	20	50	20	76	-	-	-	-	1
	S3760021000	1079150 20374544 20585555 21172388	Volvo	294	458	752	100	16	50	20	76	-	-	-	-	1
	S3760022000	0237021600 0237021900 0237023600 0237025200 0237220400 0237220402 0237221400 0237228300 0237228302 0237229000 0237320002 1336821 M001022 UJB0350 196107 196112 6502038 02376002600 013250 013961 014118 014750 0196103 020044 028363 1041843	BPW BPW BPW BPW BPW BPW BPW BPW BPW BPW BPW BPW DAF Fruehauf Fruehauf Gigant Gigant Kögel SAF Schmitz Schmitz Schmitz Schmitz Schmitz Schmitz Schmitz Schmitz Schmitz	178	344.5	522.5	55	24	55	24	76	-	-	-	-	1
	S3760023000	345496 02376007000 02376007001 02376007002 02376007052 1012386	Kögel SAF SAF SAF SAF Schmitz	192	218	410	78	20	68	20	76	-	-	-	-	1

① Zie pagina 62

② De originele onderdeelnummers dienen alleen voor vergelijkingsdoeleinden en identificatie.





## Schokdempers

	Onderdeelnummer ①	Ref. Nr. OEM ②	Toepassing	Slag mm	L min. mm	L max. mm	A mm	A inn. mm	B mm	B inn. mm	C mm	A 1 mm	A 2	B 1 mm	B 2	Vers.
	S3760024000	4288 A06030510 112297	Kaiser LOHR Rolfo	151	332	483	46	20	46	20	80	-	-	-	-	1
	S3760025000	6500480 02376007200 02376007201 02376007202 02376007252 1021298	Kögel SAF SAF SAF SAF Schmitz	190	342	532	78	20	68	20	-	-	-	-	-	1
	S3760027000	2376001002 21221348 8404174 02376001001 02376001002 02376001400 02376001800 012486 014134 016436 1090122 6503123L 6503608P 6504638G 6506635A 6506636B	Kaiser Meritor/ROR SAE SAF SAF SAF SAF Schmitz Schmitz Schmitz Schmitz Trailor Trailor Trailor Trailor	160	314	474	-	20	62	20	80	-	-	-	-	1
	S3760028000	016508 DW912565 1086689 1093975 D8A912565S UR600087 1319568 1280199	Schmitz	116	269	385	58	16	58	16	76	-	-	-	-	1
	S3760028100 (incl. Tapbout)	016508 DW912565 1086689 1093975 D8A912565S UR600087 1319568 1280199	Schmitz	116	269	385	58	16	58	16	76	-	-	-	-	1
	S3760029000	DW912801A 1008054 1093977 1086690 D8A912801 UR600088 1204307 1359146	Schmitz	118	267	385	82	16	58	16	76	-	-	-	-	1

① Zie pagina 62

② De originele onderdeelnummers dienen alleen voor vergelijkingsdoeleinden en identificatie.







## Schokdempers

	Onderdeelnummer ①	Ref. Nr. OEM ②	Toepassing	Slag mm	L min. mm	L max. mm	A mm	A inn. mm	B mm	B inn. mm	C mm	A 1 mm	A 2	B 1 mm	B 2	Vers.
	S3760029100 (incl. Tapbout)	DW912801A 1008054 1093977 1086690 D8A912801 UR600088 1204307 1359146	Schmitz	118	267	385	82	16	58	16	76	-	-	-	-	1
	S3760030000	1336824 508571 21222271 21224331 21224531 21224745 902368 902404 912368 9302060 1065667	DAF Hendrickson Meritor/ROR Meritor/ROR Meritor/ROR Meritor/ROR Rockwell Rockwell Rockwell SAE Schmitz	124	303	427	58	24	58	24	76	-	-	-	-	1
	S3760031000	1336823 1336827 10490505651 87001 LEI18000270052 7800 21208363 21216058 21224034 5000790689 8404174 02376001000 6503123L 6503608P 6506635A 503075 503076 902194	DAF DAF Fruehauf Fruehauf Kaiser Langendorf Meritor/ROR Meritor/ROR Meritor/ROR Renault SAE SAF Trailor Trailor Trailor Weweler Weweler Weweler	159	320	479	62	24	62	24	80	-	-	-	-	1
	S3760032000	0237029200 0237228800 0237228802 0237229200 8900020166 6502932 02376003100 02376003150 013290 016271 1079383	BPW BPW BPW BPW Kassbohrer Kögel SAF SAF Schmitz Schmitz Schmitz	190	351	541	55	24	55	24	-	-	-	-	-	1

① Zie pagina 62

② De originele onderdeelnummers dienen alleen voor vergelijkingsdoeleinden en identificatie.





## Schokdempers

	Onderdeelnummer ①	Ref. Nr. OEM ②	Toepassing	Slag mm	L min. mm	L max. mm	A mm	A inn. mm	B mm	B inn. mm	C mm	A 1 mm	A 2	B 1 mm	B 2	Vers.
	S3760033000	0237027000 0237228900 0237228902 CF153506 CF153618 196119 196121 F11000335 112320 02376002700 02376003500 013774 016270 017750 1251686	BPW BPW BPW Fruehauf Fruehauf Gigant Gigant Kaiser Rolfo SAF SAF Schmitz Schmitz Schmitz Schmitz	136	293	429	55	24	55	24	76	-	-	-	-	1
	S3760035000	M001537 M007950 M076480 M200052 M200133 UJB0364 UJB0563 UJB0565 UJB1124C 1526855	Fruehauf	155	319	474	55	20	55	20	76	-	-	-	-	1
	S3760038000	1315959 1370267 1420474 1867874 1868263 1861117 1868264	Scania	280	410	690	-	-	46	22	63	73	M14x1,5	-	-	3
	S3760040000	0237021800 0237026700 0237026702 196116 02376001900 014050	BPW BPW BPW Gigant SAF Schmitz	297	468	765	55	24	55	24	76	-	-	-	-	1
	S3760045000	81417226012 81417226009 81417226033 81417226037 81417226050 81417226014 81417226016 81417226038 81417226042	MAN	94	220	314	40	20	-	-	-	-	-	69	M10x1,0	5
	S3760046000	81417226010 81417226013 81417226034 81417226035 81417226015 81417226017 81417226045	MAN	73	219	292	40	14	40	14	-	-	-	-	-	6

① Zie pagina 62

② De originele onderdeelnummers dienen alleen voor vergelijkingsdoeleinden en identificatie.

## Schokdempers





	Onderdeelnummer ①	Ref. Nr. OEM ②	Toepassing	Slag mm	L min. mm	L max. mm	A mm	A inn. mm	B mm	B inn. mm	C mm	A 1 mm	A 2	B 1 mm	B 2	Vers.
	S3760048000	00196170 515069175	Gigant Krone	108	268	376	55	24	55	24	76	-	-	-	-	1
	S3760052000	A0063269900 A0053260900 A3753260200 A9583260900 A0003201530 A0053265800 A0053265700 A0053265900 A0063266700 A0053266300	Mercedes Benz	340	516	856	105	16	50	16	76	-	-	-	-	1
	S3760053000	A0063237800 A0053239600 A0063236000 A0063237300 A0063237900 A0073231400 A3573230000 A9583230800 A9583230900 A0033232000 A0033232100 A0043235600 A3753230600 A0053239500 A0063236100 A0013231100 A0023231000 A0023231100 A0023231600 A0023235400 A0033231000 A0043233600 A0043234900	Mercedes Benz	324	479	803	50	16	50	16	-	-	-	-	-	1
	S3760058000	A9583170703 A9428900519	Mercedes Benz	45	166	211	32	12	32	12	49	-	-	-	-	1

① Zie pagina 62

② De originele onderdeelnummers dienen alleen voor vergelijkingsdoeleinden en identificatie.







## Schokdempers

	Onderdeelnummer ①	Ref. Nr. OEM ②	Toepassing	Slag mm	L min. mm	L max. mm	A mm	A inn. mm	B mm	B inn. mm	C mm	A 1 mm	A 2	B 1 mm	B 2	Vers.
	S3760065000	LE11650050052 A423016002 A9463260300 21215607 21215742 21215751 21215807 21221306 015978 017090 902022SP2 9102022	KAISER Mercedes Benz Mercedes Benz Meritor/ROR Meritor/ROR Meritor/ROR Meritor/ROR Meritor/ROR Schmitz Schmitz Weweler Weweler	135	294	429	62	20	62	20	76	-	-	-	-	1
	S3760071000	1075478	Volvo	108	221	329	-	-	46	20	55	-	M12x1.75	-	-	7
	S3760077000	1079151 20374543 20585556 21172387 7420374543	Volvo	335	498	833	100	16	50	20	76	-	-	-	-	1
	S3760080000	81437026004 81437026005 81437026078 81437026014 81437026086	MAN	330	540	870	105	20	55	24	63	-	-	-	-	1
	S3760081000	81437026076 81437026011 81437026012	MAN	270	429	699	105	20	55	24	-	-	-	-	-	1

① Zie pagina 62

② De originele onderdeelnummers dienen alleen voor vergelijkingsdoeleinden en identificatie.





## Schokdempers

	Onderdeelnummer ①	Ref. Nr. OEM ②	Toepassing	Slag mm	L min. mm	L max. mm	A mm	A inn. mm	B mm	B inn. mm	C mm	A 1 mm	A 2	B 1 mm	B 2	Vers.
	S3760082000	81437016079 81437016093 81437016162 81437016163 81437016166 81437016167 81437016172 81437016217 81437016219 81437016221 81437016230 81437016232 81437016266 81437016318 81437016324 81437016325 81437016326 81437016343 81437016386 81437016538 81437016539 81437016542 81437016543 81437016550 81437016572 81437016606 81437016607	MAN	199	318	517	-	-	-	-	76	75	M14x1.5	75	M14x1.5	2
	S3760083000	81437016672 81437016689 81437016706 81437016714 81437016730 81437016732 81437016768 81437016769 81437016787 81437016801 81437016806 81437016830 81437016892 81437016924 8152712	MAN MAN MAN MAN MAN MAN MAN MAN MAN MAN MAN MAN MAN MAN MAN Volvo	179	309	488	-	-	-	-	63	81	M14x1.5	80	M14x1.5	2
	S3760084000	81437016793 81437016804	MAN	261	386	647	-	-	50	16	63	61	-	-	-	3
	S3760086000	0237021000 0237021700 0237021800 075278	BPW BPW BPW Schmitz	322	479	801	55	24	55	24	76	-	-	-	-	1

① Zie pagina 62

② De originele onderdeelnummers dienen alleen voor vergelijkingsdoeleinden en identificatie.

## Schokdempers

	Onderdeelnummer ①	Ref. Nr. OEM ②	Toepassing	Slag mm	L min. mm	L max. mm	A mm	A inn. mm	B mm	B inn. mm	C mm	A 1 mm	A 2	B 1 mm	B 2	Vers.
	S3760091000	81437016934 81437016016 81437026148	MAN	280	456	736	62	20	62	20	76	-	-	-	-	1
	S3760096000	20769819 20532767 1094523 8159833	Volvo	265	450	715	100	16	66	16	63,4	-	-	-	-	1
	S3760097000	7421243060 7421909816 21243048 21862164	Renault Renault Volvo Volvo	315	456	771	100	16	-	-	-	-	-	79	-	4
	S3760098000	21224778 21226989 1134526	MERITOR / ROR MERITOR / ROR Schmitz	107	273	380	57	24	57	24	80	-	-	-	-	1

## Tapbout

	Onderdeelnummer ①	Ref. Nr. OEM ②	Toepassing	Geschikt voor
	S3410001000	1086695 1061572 1008055	Schmitz	S3760028100 S3760029100

① Zie pagina 62

② De originele onderdeelnummers dienen alleen voor vergelijkingsdoeleinden en identificatie.





[www.sauer-qualityparts.com](http://www.sauer-qualityparts.com)



## FIJNREGELAARS

Truck en Trailer onderdelen

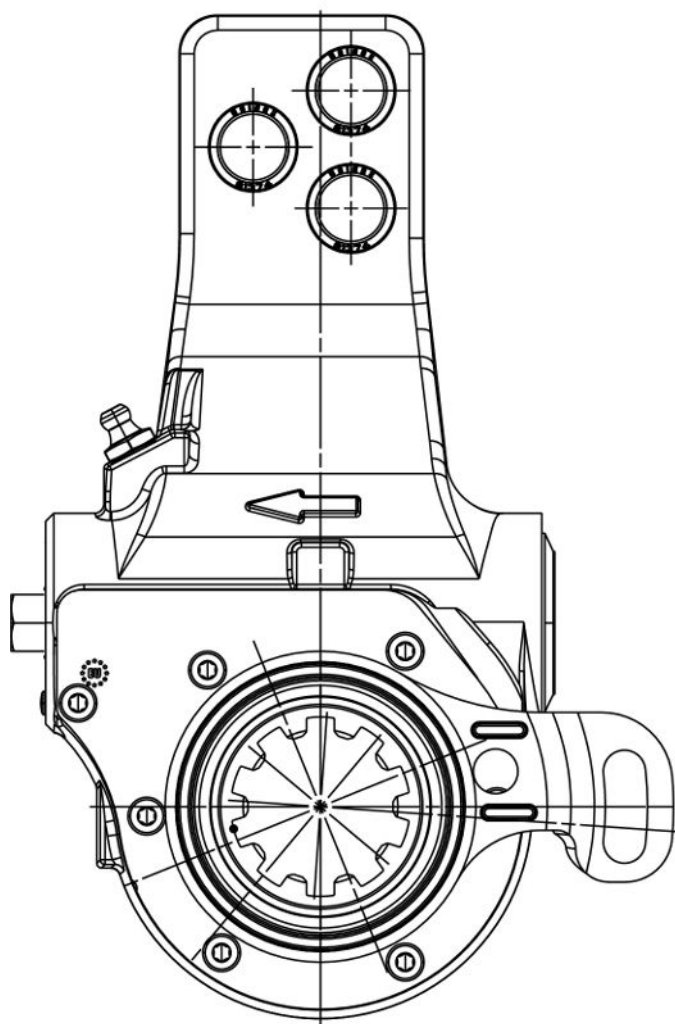

Alle automatische SAUER QUALITY PARTS remstellers zijn uitgerust met een zelf-stellend mechanisme.

Hierdoor bieden ze een gemakkelijke installatie en garanderen een langere levensduur met weinig slijtage.

## Fijnregelaars

Onderdeelnummer ①	Ref. Nr. OEM ②	Toepassing	LH / RH	Ref. Nr. Haldex ②
S1750001000	0517482212	BPW	LH / RH	80019 72876 72875 79327
	0517482213	BPW		
	0517482220	BPW		
	0517482222	BPW		
	0517482223	BPW		
	0517482493	BPW		
	0557482021	BPW		
	0557482121	BPW		
	0557482190	BPW		
	0557482220	BPW		
	0557482430	BPW		
	0557482432	BPW		
	0557482433	BPW		
	0557482552	BPW		
	0557482553	BPW		
	0557482763	BPW		
10613835	Van Hool			
S1750003000	1325313	DAF	LH / RH	80020 72788
	1325313A	DAF		
	1325313R	DAF		
	21222694	Meritor/ROR		
	21223694	Meritor/ROR		
	21229249	Meritor/ROR		
S1750004000	03434350203	SAF	LH / RH	80022 79005
	03434350202			
	03434350201			
	03434350204			
	04175008500			
	04175008501			
	04175015401			
	04175022800			
	04175024000			
	04175024900			
	04175031400			
	04175037400			
S1750005000	M002416	SMB	LH / RH	80023 72274 79630
	M023565	Fruehauf		
S1750016000	4731113	DAF	LH	80000
	6310215	DAF		
	A3874200338	Mercedes Benz		
	A6174200338	Mercedes Benz		
	A6194200738	Mercedes Benz		
	A6554200038	Mercedes Benz		
	A9424200238	Mercedes Benz		
	A9424200438	Mercedes Benz		
	A9454200238	Mercedes Benz		
B1006	Renault			

① Zie pagina 75

② De originele onderdeelnummers dienen alleen voor vergelijkingsdoeleinden en identificatie.

## Fijnregelaars

Onderdeelnummer ①	Ref. Nr. OEM ②	Toepassing	LH / RH	Ref. Nr. Haldex ②
S1750016100	4731121 944001169 A3874200238 A6174200438 A6194200638 A6554200138 A9424200338 A9424200538 A9424290338 A9454200338 B1007	DAF DAF Mercedes Benz Mercedes Benz Mercedes Benz Mercedes Benz Mercedes Benz Mercedes Benz Mercedes Benz Mercedes Benz Renault	RH	80001
S1750017000	A6194200038 A6194200238 A6234201238 A6234201438 A6524200038 A6584200238 A9424200038 A9424200938 A9424201238 A9454200038 4731295	Mercedes Benz Mercedes Benz Mercedes Benz Mercedes Benz Mercedes Benz Mercedes Benz Mercedes Benz Mercedes Benz Mercedes Benz Mercedes Benz Volvo	LH	80008C 72062
S1750017100	A9454200138 A9424201338 A9424200838 A6524200138 A6194200138 A6584200338 A6234201338 A6194200338 A6234201538 A9424200138 A6584200138	Mercedes Benz	RH	80009C 72594
S1750018000	A9454200438	Mercedes Benz	RH	80014
S1750018100	A9454200938	Mercedes Benz	LH	80030
S1750019000	A3574200538 A0002200071	Mercedes Benz	LH / RH	72059
S1750020000	81506106263 81506106253	MAN	LH	80176 80084
S1750020100	81506106266 81506106258	MAN	RH	80183 80086
S1750021000	81506106261 81506106251	MAN	LH	80180 80092

① Zie pagina 75

② De originele onderdeelnummers dienen alleen voor vergelijkingsdoeleinden en identificatie.



## Fijnregelaars

Onderdeel- nummer ①	Ref. Nr. OEM ②	Toepassing	LH / RH	Ref. Nr. Haldex ②
S1750021100	81506106262 81506106252	MAN	RH	80181 80093
S1750022000	81506106211 81506106165 81506106235 81506109211	MAN	LH	79208 72303 72968
S1750022100	81506106210 81506106166 81506106234 81998033226	MAN	RH	79209 72304 72969
S1750023000	81506106231 81506106081 81506106151 81506106057 81506106066 81506109231	MAN	LH / RH	79212 72972
S1750024000	81506106212 81506106154 81506106084 81506106048 81506106058 81506107154	MAN	RH	79211
S1750024100	81506106213 81506106153 81506106083 81506106049 81506106059	MAN	LH	79210
S1750025000	278737 394181 1112833 1789561 1865748 2009819	Scania	LH	79877 72660
S1750025100	278738 394182 1112834 1789562 1865747 2009820	Scania	RH	79878 72661
S1750026000	1358634 1789567	Scania	RH	79442
S1750026100	1358635 1789568	Scania	LH	79443

① Zie pagina 75

② De originele onderdeelnummers dienen alleen voor vergelijkingsdoeleinden en identificatie.

## Fijnregelaars

Onderdeelnummer ①	Ref. Nr. OEM ②	Toepassing	LH / RH	Ref. Nr. Haldex ②
S1750029000	755616 755616R 755616A	DAF	LH	72704
S1750029100	755617 755617R 755617A	DAF	RH	72705
S1750030000	5010260117	Renault	LH	79310 79077
S1750030100	5010260118	Renault	RH	79311 79078
S1750033000	0557482873 0557483013 0517482633 0517482673 0517483173	BPW	LH / RH	80530
S1750034000	04175032700	SAF	LH	80303
S1750034100	04175032800	SAF	RH	80302
S1750035000	04175032500	SAF	LH	80293
S1750035100	04175032600	SAF	RH	80294
S1750036000	81506106264 81506106256	MAN	RH	80177
S1750037000	81506106255 81506106259	MAN	LH	80178
S1750038000	81506106254 81506106260	MAN	RH	80179

① Zie pagina 75

② De originele onderdeelnummers dienen alleen voor vergelijkingsdoeleinden en identificatie.



[www.sauer-qualityparts.com](http://www.sauer-qualityparts.com)



## VELGEN

Truck en Trailer onderdelen

Stalen velgen





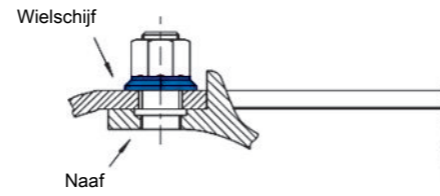

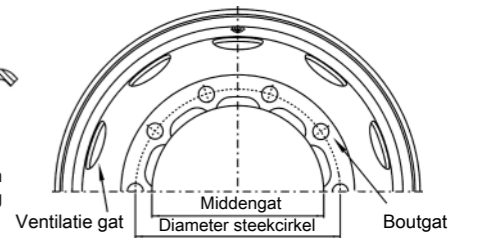
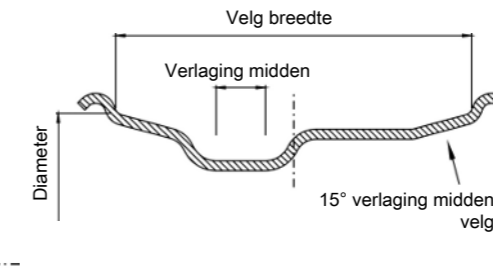
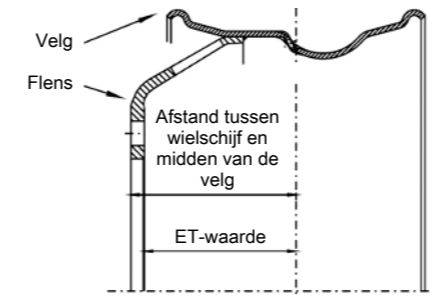
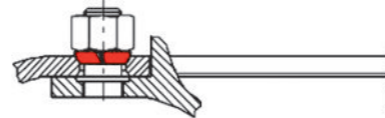

Naaf centrering



Wielbout centrering



	Onderdeelnummer ①	Velgmaat Inch	ALV (buitenliggend ventiel)	Centrering	ET-waarde mm	Afstand tussen wielschijf en midden van de velg	Middengat Ø	Diameter steekcirkel Ø	Aantal gaten	Max. Draagvermogen kg	Dikte mm	Gewicht kg	Ventilatie gat	Ventiel
	S3324480722	22.5 x 7.50	✓	HC	148	161	281	335	10	3250	13	46,2	10	V3-22-1
	S3324510822	22.5 x 8.25	✓	HC	151	164	281	335	10	3750	13	47,6	10	V3-20
	S3324610922	22.5 x 9.00	✓	HC	161	175	281	335	10	4500	14	49,7	10	V3-22-1
	S3324001122	22.5 x 11.75	✓	HC	0	-	281	335	10	5000	12	43	10	V3-22-1
	S3324201122	22.5 x 11.75	✓	HC	120	-	281	335	10	5000	14	46	10	V3-22-1
	S3324351122	22.5 x 11.75	✓	HC	135	-	281	335	10	5000	14	45,8	10	V3-22-1

① Dit zijn SAUER QUALITY PARTS onderdeelnummers. Het zijn geen originele OEM of OEM geautoriseerde producten, maar het is een Aftermarket product.



[www.sauer-qualityparts.com](http://www.sauer-qualityparts.com)



## LUCHTKETELS

Truck en Trailer onderdelen

## Universele Luchtketels Stalen

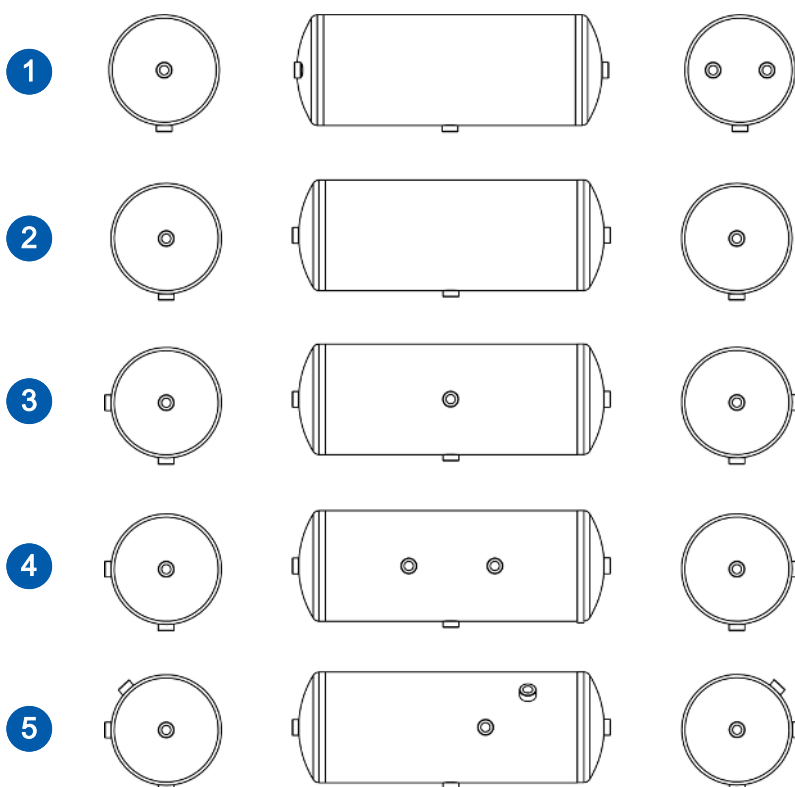
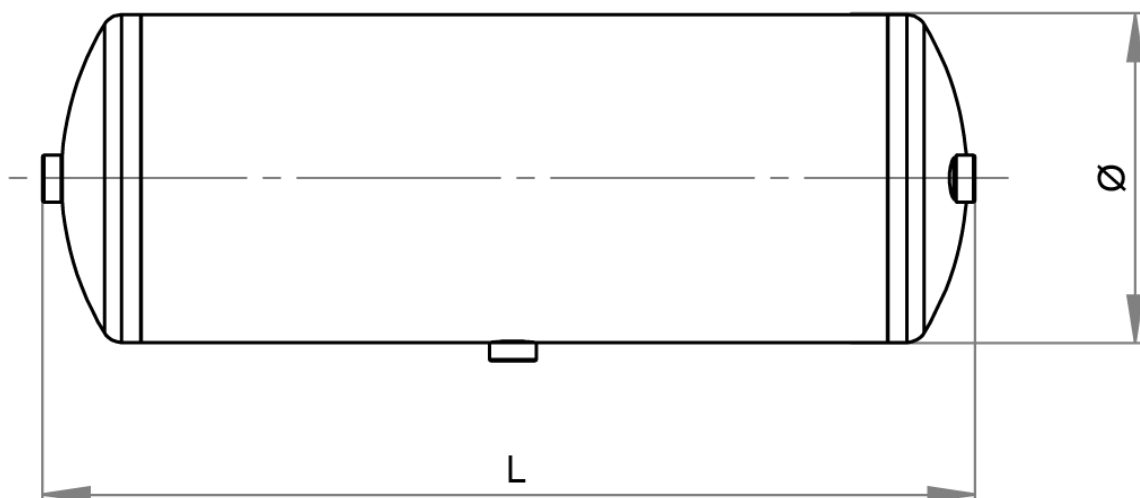

1 ... 5      Versie 1 ... 5

**Alle luchtketels voldoen aan de EN-286-2(1997) normering.**



## Universele Luchtketels Stalen

Onderdeelnummer ①	Volume	Ø mm	L mm	Bar	Versie	Wabco ②	Knorr ②	Haldex ②	PE ②
S1050020010	5	206	215	15,5	1	–	–	030350009	–
S1050001010	10	206	355	15,5	1	9504100040	VB3301/206 VB3701/206	030350209	076.450-10A 026.053-00A 076.484-00A
S1050021010	15	206	525	15,5	1	9504150050	VB33015/206	030363609	026.039-00A 026.043-00A
S1050016010	20	206	690	15,5	1	4510203000 9504200030	VB3302/206 VB3702/206	030350509	076.450-00A 016.231-00A
S1050003010	20	246	500	12,5	1	9505200030	VB3302/246 VB3702/246	030350609	016.229-00A 016.232-00A 036.053-00A 076.450-20A
S1050074010	25	246	590,5	12,5	1	–	–	–	036.358-00A
S1050004010	30	246	700	12,5	1	9505300020 9505300030	VB3303/246 VB3703/246	030350909	076.451-00A 016.233-00A
S1050012010	30	276	588	15	1	9507300070	VB3303/276 VB3703/276	–	076.452-10A 016.224-00A
S1050023010	36	300	582	12,5	2	–	–	–	–
S1050024010	37	246	860	15,5	1	4510373010 9505370010	–	030001319D	076.451-10A
S1050025010	40	246	922	15,5	1	9505400010	VB3304/246 VB3704/246	303501509	076.452-00A 016.234-00A 036.057-00A
S1050005010	40	276	745	12,5	1	9507400020	VB3304/276 VB3704/276	030351209	076.453-00A 016.235-00A 036.056-00A
S1050048010	40	310	625	12,5	1	9507409060	VB3304/310	030362009	076.459-00A
S1050026010	40	310	626	12,5	3	–	–	–	–
S1050032010	45	300	740	12,5	3	9508450020	–	–	–
S1050033010	45	300	740	12,5	4	9508450010	–	032304513S	076.488-00A
S1050050010	60	246	1352	12,5	1	4510603010 9505600010 9505600020	VB3306/246	030351809	076.454-10A
S1050007010	60	276	1100	12,5	1	9507600020	VB3306/276 VB3706/276	030351609	076.454-00A

① Zie pagina 83

② De originele onderdeelnummers dienen alleen voor vergelijkingsdoeleinden en identificatie.

## Universele Luchtketels Stalen

Onderdeelnummer ①	Volume	Ø mm	L mm	Bar	Versie	Wabco ②	Knorr ②	Haldex ②	PE ②
S1050049010	60	300	950	12,5	4	9500600090	–	032306013S	076.462-00A
S1050006010	60	310	895	12,5	1	9500600030	VB3306/310 VB3706/310	030360809	076.455-00A
S1050028010	60	396	565	12,5	1	9500600040	VB3306/396 VB3706/396 VB3406/396	030351709	076.456-00A
S1050029010	80	310	1153	12,5	1	–	VB3308/310 VB3708/310	–	076.560-00A
S1050010010	80	396	730	10	1	9500800020	VB3308/396 VB3708/396 VB3408/396	030352009	076.457-00A
S1050013010	120	396	1067	10	1	–	–	–	076.463-00A

① Zie pagina 83

② De originele onderdeelnummers dienen alleen voor vergelijkingsdoeleinden en identificatie.



## Voer Tuig specifieke Luchtketels Stalen

Onderdeelnummer ①	Ref. Nr. OEM ②	Toepassing	Volume	Ø mm	L mm	Bar
S1050059010	A0014320701 A0014321001 A0014325801 A0014329001 A0014329101 A0034320301 A0044320501 A0054323001 A0064323401 A3754321901	Mercedes Benz	4	144	315	15,5
S1050061010	81514010037 81514010078 81514010114 81514010120 81514010194 81514010224 81514010515	MAN	4	154	273	12,5
S1050070010	A0044320601 A0054323101 A0064323501 A3754322001	Mercedes Benz	5,4	144	411,5	15,5
S1050072010	A0054322001 A0034320601	Mercedes Benz	6	144	453	15,5
S1050045010	A0054323301 A0064323701 A9584320201 A0034320801	Mercedes Benz	10	206	366	15,5
S1050064010	A0034320801 A0074321101 21018310	Mercedes Benz Mercedes Benz Volvo	10	206	371	15,5
S1050036010	A0054324001 A0064324101 A3754323501	Mercedes Benz	10	246	266	15,5
S1050035010	A0064324201 A0044326401 A0054324101 A0064328001 A3754323601	Mercedes Benz	10	246	277	15,5
S1050021010	4803545 42015440 98480832 504047697 504197586 5949780684	Iveco	15	206	525	15,5

① Zie pagina 83

② De originele onderdeelnummers dienen alleen voor vergelijkingsdoeleinden en identificatie.

## Voer Tuig specifieke Luchtketels Stalen

Onderdeelnummer ①	Ref. Nr. OEM ②	Toepassing	Volume	Ø mm	L mm	Bar
S1050034010	A0054322401 A0064325001 A0034323301	Mercedes Benz	15	276	326	15,5
S1050038010	A0054324201 A0064323801 A3754323301	Mercedes Benz	20	206	677	15,5
S1050069010	A0044321901 A0054323401 A0064324301 A3754322301	Mercedes Benz	20	246	497	15,5
S1050044010	A0064326401	Mercedes Benz	20	246	509	15,5
S1050003010	A0004324801 A0004325101 A0014327501 A0024320001 A0034321201 A0034321301	Mercedes Benz	20	246	500	12,5
S1050073010	A0034321401 A0034321501 A0044323101 A0054322101 A0054323601 A0064325101 A0064325201	Mercedes Benz	20	276	412	15,5
S1050051010	0501207 1227887 1233666 1616331	DAF	20	300	373	12,5
S1050100010	81514010228 81514010238 81514010257 81514016029 81514010227 81514010258 81514010244 81514016031	MAN	20	310	312	12,5
S1050039010	A0044326801 A0054324301 A0064323901	Mercedes Benz	25	206	828	15,5

① Zie pagina 83

② De originele onderdeelnummers dienen alleen voor vergelijkingsdoeleinden en identificatie.

## Voer Tuig specifieke Luchtketels Stalen

Onderdeelnummer ①	Ref. Nr. OEM ②	Toepassing	Volume	Ø mm	L mm	Bar
S1050022010	81514010150 81514010024 81514010032 81514010062 81514010067 81514010070 81514010084 81514015001 81514015022 81514015026 81514015027 81514015032 81514015043 81514015004 81514015070	MAN	25	246	589	15,5
S1050011010	A0034329301 A0044324201 A0054323801 A0064324401 A3754323701 7420904407 20904407	Mercedes Benz Mercedes Benz Mercedes Benz Mercedes Benz Mercedes Benz Renault Volvo	25	246	604,5	15,5
S1050068010	A0034329301 A0074320301	Mercedes Benz	25	246	606,5	15,5
S1050065010	A0034329401 A0054322601 A0064325301 A0074324501 A3754322601	Mercedes Benz	25	276	495	15,5
S1050071010	A0034323201 A0054322301 A0064324501 A3754322401	Mercedes Benz	30	246	714,5	15,5
S1050055010	5010525446	Renault	30	250	718	13
S1050060010	1519220 5021170384 1357950 1383777 2089991 488217	DAF Renault Scania Scania Scania Scania	30	276	571	14,5

① Zie pagina 83

② De originele onderdeelnummers dienen alleen voor vergelijkingsdoeleinden en identificatie.

## Voer Tuig specifieke Luchtketels Stalen

Onderdeelnummer ①	Ref. Nr. OEM ②	Toepassing	Volume	Ø mm	L mm	Bar
S1050043010	A0044324301 A0054322201 A0054323901 A0064325401 A0064325501 A0074324701 A3754322701 A3754322801 7420904408 20904408	Mercedes Benz Mercedes Benz Mercedes Benz Mercedes Benz Mercedes Benz Mercedes Benz Mercedes Benz Mercedes Benz Mercedes Benz Reanult Volvo	30	276	585	15,5
S1050075010	A0004328801 A0014320201 A0024320801 A0034322101 A0074322101	Mercedes Benz	30	276	599,5	15,5
S1050062010	81514010180 81514010204 81514010239 81514010245 81514010249 81514010253 81514016013 81514016021	MAN	30	310	462	12,5
S1050037010	A0054323501 A0064324601	Mercedes Benz	35	246	821	15,5
S1050042010	A0054222701 A0054322701 A0064325601 A0034329501	Mercedes Benz	35	276	663	15,5
S1050047010	1227888 1616332 1733544 1233667	DAF	36	300	606	12,5
S1050041010	A0054322901 A0064324701	Mercedes Benz	40	246	932,5	15,5
S1050077010	A0054322501 A0034323901 A0064325701	Mercedes Benz	40	276	758	15,5
S1050063010	81514010182 81514010241 81514016015 81514010206 81514010251 81514010255	MAN	40	310	605	12,5

① Zie pagina 83

② De originele onderdeelnummers dienen alleen voor vergelijkingsdoeleinden en identificatie.

## Voer Tuig specifieke Luchtketels Stalen

Onderdeelnummer ①	Ref. Nr. OEM ②	Toepassing	Volume	Ø mm	L mm	Bar
S1050076010	A0034329901 A0054322801 A0064325801	Mercedes Benz	45	276	844	15,5
S1050040010	A0054323701 A0064324901	Mercedes Benz	60	246	1369	15,5
S1050006010	1935517 050459	Scania Schmitz	60	310	895	12,5
S1050052010	A0004321101	Mercedes Benz	85	276	1503	12,5
S1050030010	1935520 050462	Scania Schmitz	100	396	915	10

① Zie pagina 83

② De originele onderdeelnummers dienen alleen voor vergelijkingsdoeleinden en identificatie.

## Spanbanden

Onderdeelnummer ①	Ø mm	L mm	L1 mm	Wabco ②	Knorr ②	Haldex ②	PE ②
S4050020600	206	225	122	4519992062	VB3206/2	307020600	076.500-00A
S4050024600	246	267,5	162	4519992462 4519011012	VB3246/2	307024600	076.501-00A
S4050027600	276	301	1100	4519992762 4519011022	VB3276/2	307027600	076.502-00A
S4050031000	310	332	227	4519993102 4519011032	VB3310/2	307031000	076.503-00A
S4050039600	396	416	307	4519993962	VB3396/2	307039600	076.504-00A

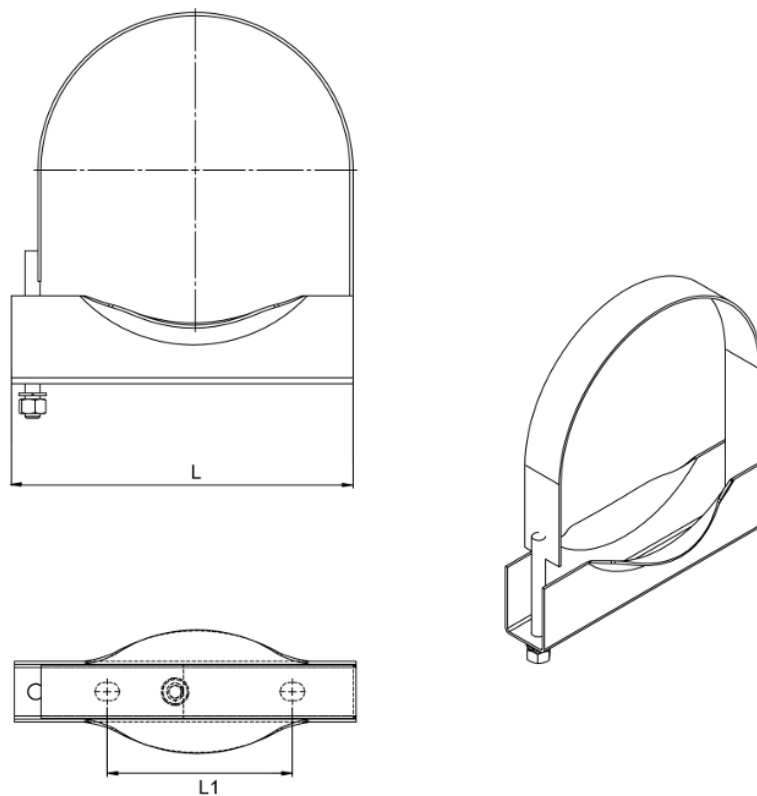

① Zie pagina 83

② De originele onderdeelnummers dienen alleen voor vergelijkingsdoeleinden en identificatie.

## Universele Luchtketels Stalen met montagebeugel

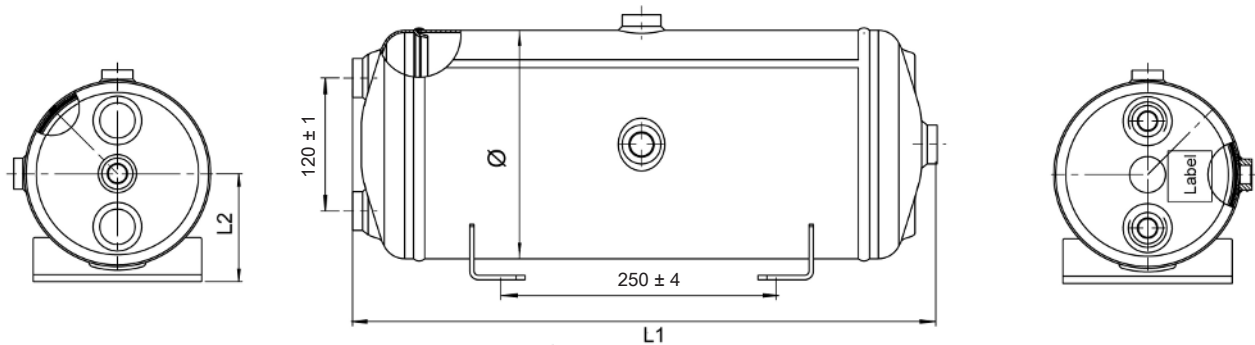

Onderdeelnummer ①	Volume	Ø mm	L1 mm	L2 mm	Bar	Frauenthal ②
S1050080010	15	206	527	122	15,5	902278
S1050081010	20	206	690	122	15,5	902280
S1050084010	30	246	723	153	15,5	902321
S1050085010	30	276	583	167	15,5	902393
S1050086010	40	276	758	167	12,5	902404
S1050046010	40	310	618	185	12,5	902420
S1050087010	60	276	1108	167	15,5	902408
S1050088010	60	310	893	185	12,5	902427
S1050090010	80	310	1150	185	12,5	902428
S1050091010	80	396	750	228	12,5	902439
S1050092010	100	396	915	228	12,5	902442

① Zie pagina 83

② De originele onderdeelnummers dienen alleen voor vergelijkingsdoeleinden en identificatie.

## Universele Luchtketels Stalen met montagebeugel

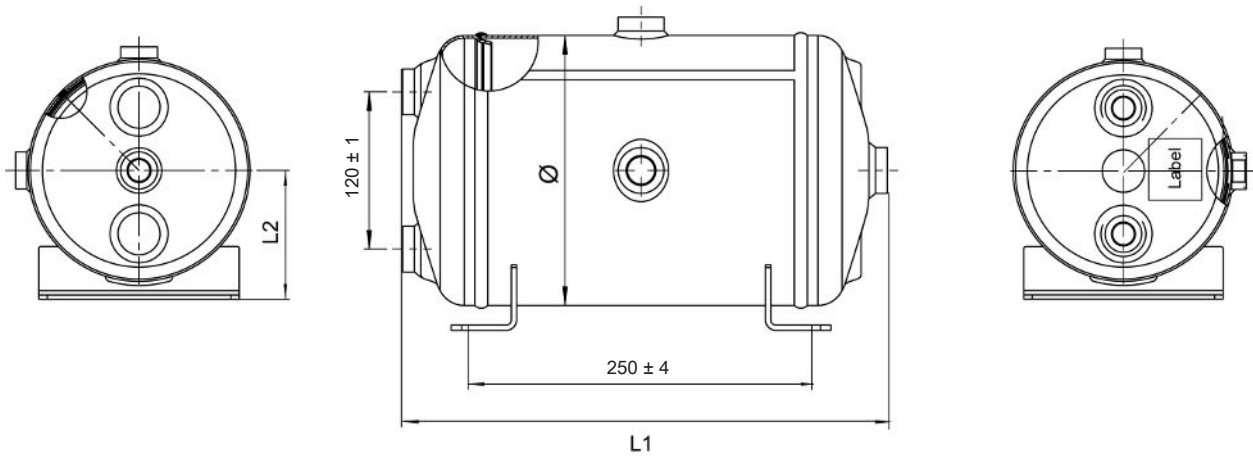

Onderdeelnummer ①	Volume	Ø mm	L1 mm	L2 mm	Bar	Frauenthal ②
S1050079010	10	206	370	122	15,5	902276
S1050082010	20	246	503	153	15,5	902311
S1050083010	20	276	414	167	15,5	902384
S1050089010	60	396	580	228	12,5	902433

① Zie pagina 83

② De originele onderdeelnummers dienen alleen voor vergelijkingsdoeleinden en identificatie.



## Voer Tuig specifieke Luchtketels Stalen met montagebeugel

S1050008010

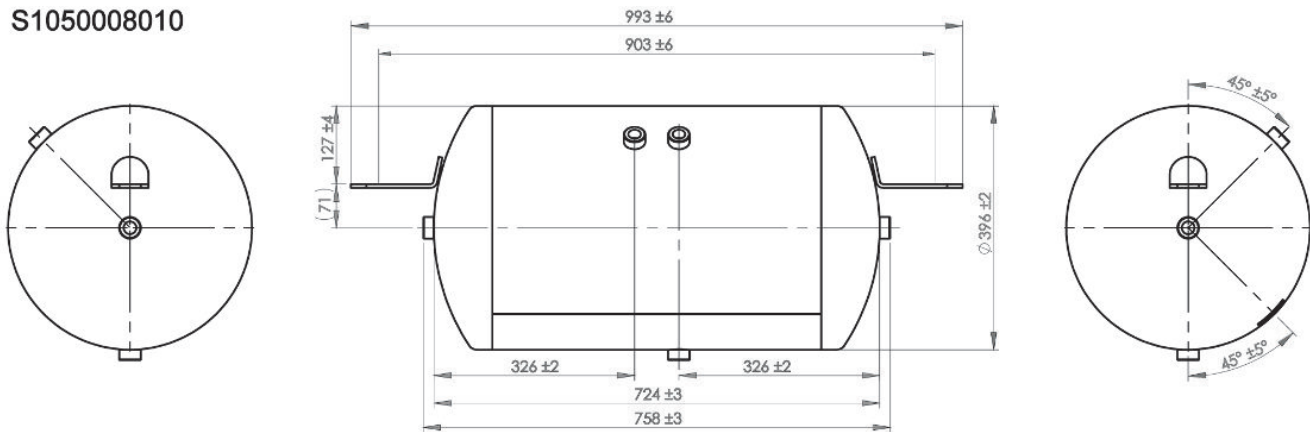

S1050009010

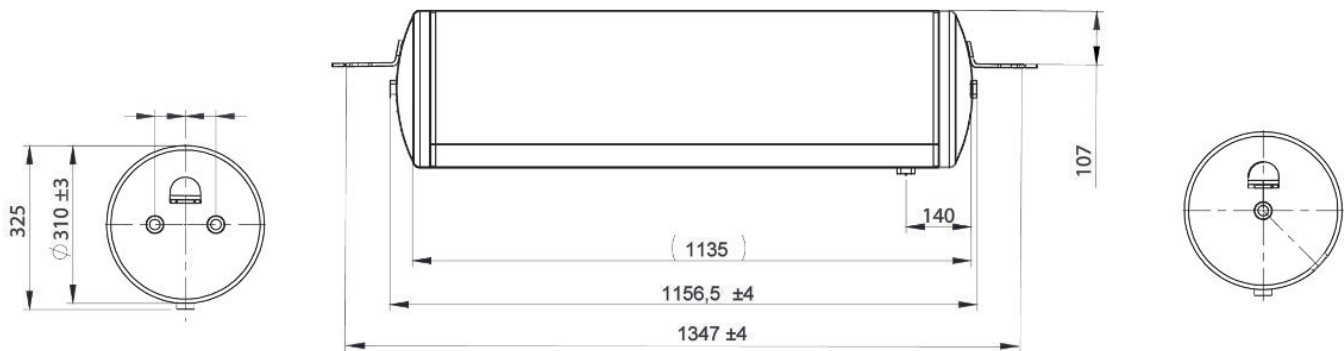

S1050031010

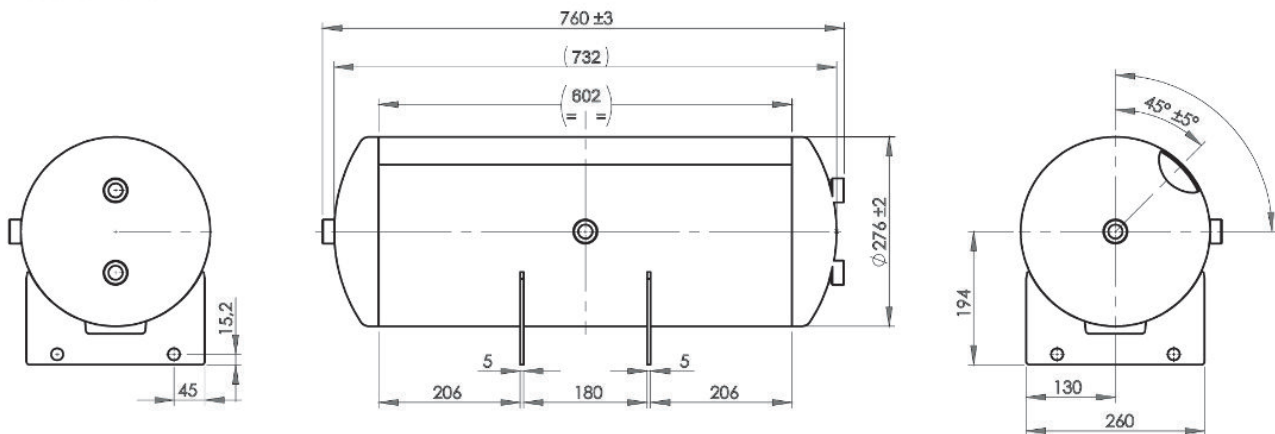

Alle stalen luchtketels voldoen aan de EN-286-2(1997) normering.

## Voer Tuig specifieke Luchtketels Stalen met montagebeugel

S1050014110

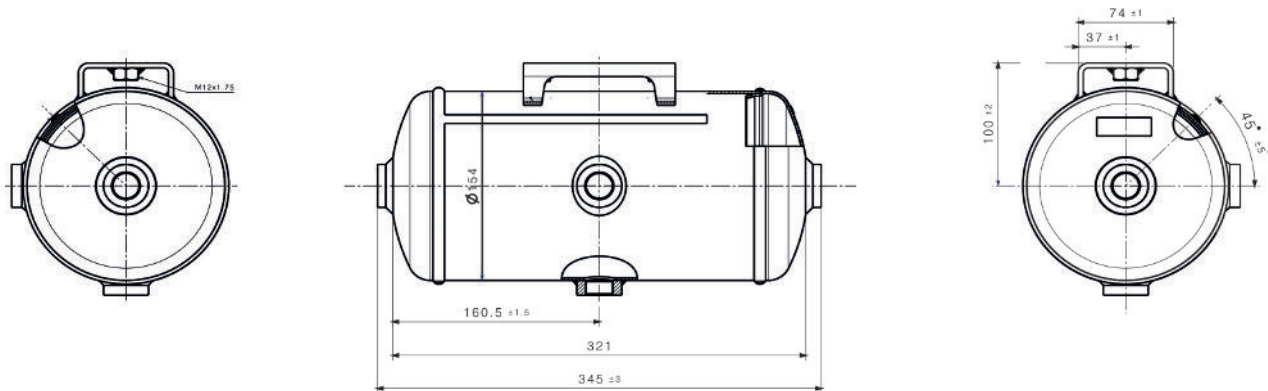

S1050098010

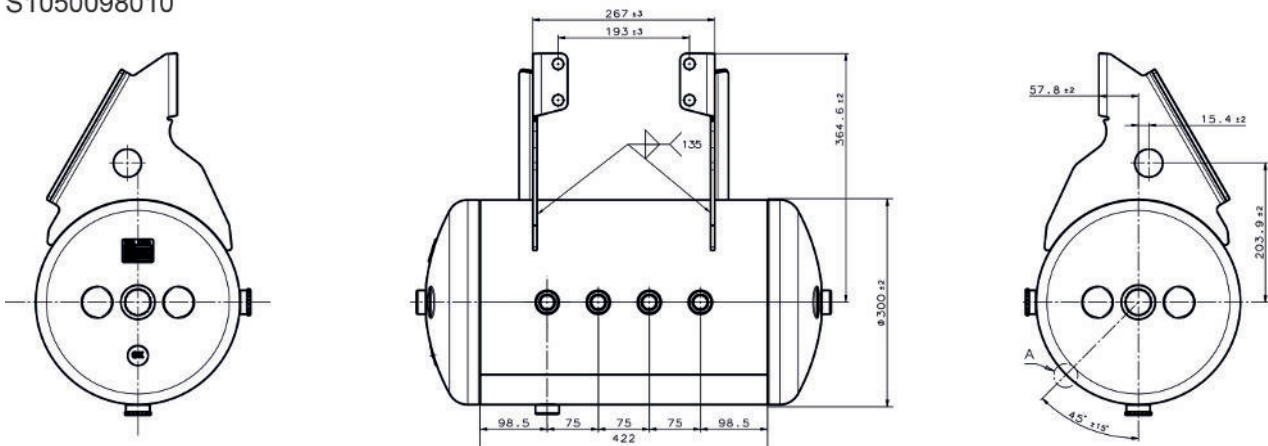

S1050099010

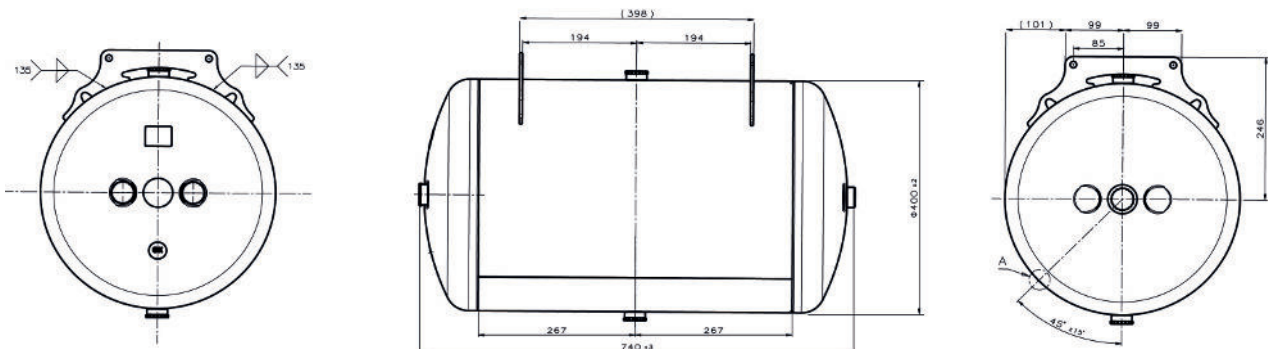

**Alle stalen luchtketels voldoen aan de EN-286-2(1997) normering.**

## Voer Tuig specifieke Luchtketels Stalen met montagebeugel

Onderdeelnummer ①	Ref. Nr. OEM ②	Toepassing	Volume	Ø mm	Bar	PE ②
S1050014110	–	–	5	154	15,5	–
S1050098010	1691625 1685296	DAF	36	300	12,5	106.518-00A
S1050031010	055798 1189865	Schmitz	40	276	12,5	296.103-00A
S1050009010	1189864 1193014 115808 051202	Schmitz	80	310	12,5	296.100-00A
S1050008010	1189863 1193012 1009330 115826	Schmitz	80	396	12,5	296.101-00A
S1050099010	055138 055192 1153350 1277932	Schmitz	80	400	12,5	296.102-00A

## Klembeugel set

Onderdeelnummer ①	Ref. Nr. OEM ②	Toepassing	Geschikt voor	PE ②
S4050100000	051375 126948 570345 1201230	Schmitz	S1050008010 S1050009010	296.151-00A

① Zie pagina 83

② De originele onderdeelnummers dienen alleen voor vergelijkingsdoeleinden en identificatie.

## Universele Luchtketels Aluminium

Onderdeelnummer ①	Volume	Ø mm	L mm	Bar	Versie	Wabco ②	Knorr ②	Haldex ②	PE ②
S1050001020	10	206	381	15,5	1	–	–	0301020615C	076.470-00A
S1050016020	20	206	685	15,5	1	–	VB4302/206	0302020615C	076.472-00A
S1050003020	20	246	509	15	1	–	VB4302/246	0302024615C	076.473-00A
S1050004020	30	246	709	12,5	1	9505309030	VB4303/246	0303024615C	076.475-00A 026.052-00A
S1050012020	30	276	591	12,5	1	–	VB4303/276	–	076.476-00A
S1050005020	40	276	766	12,5	1	9507409040	VB4304/276	0304027615C	076.479-00A
S1050048020	40	310	625	12,5	1	–	VB4304/310	0304031013C	076.537-00A 076.539-00A
S1050007020	60	276	1110	12,5	1	–	VB4306/276	–	076.482-00A
S1050006020	60	310	907	12,5	1	9509600020	VB4306/310	0306031013C	076.483-00A
S1050028020	60	396	570	12,5	1	–	VB4306/396	0306039612C	076.540-00A
S1050029020	80	310	1175	11	1	–	–	–	–
S1050010020	80	396	748	12,5	1	9500809030	VB4308/396	0308039612C	076.547-00A 076.485-00A
S1050030020	100	396	915	10	1	–	VB4310/396	03010039612C	076.486-00A
S1050013020	120	396	1067	10	1	–	–	–	076.529-00A

① Zie pagina 83

② De originele onderdeelnummers dienen alleen voor vergelijkingsdoeleinden en identificatie.

## Luchtketels aluminium met montagebeugel

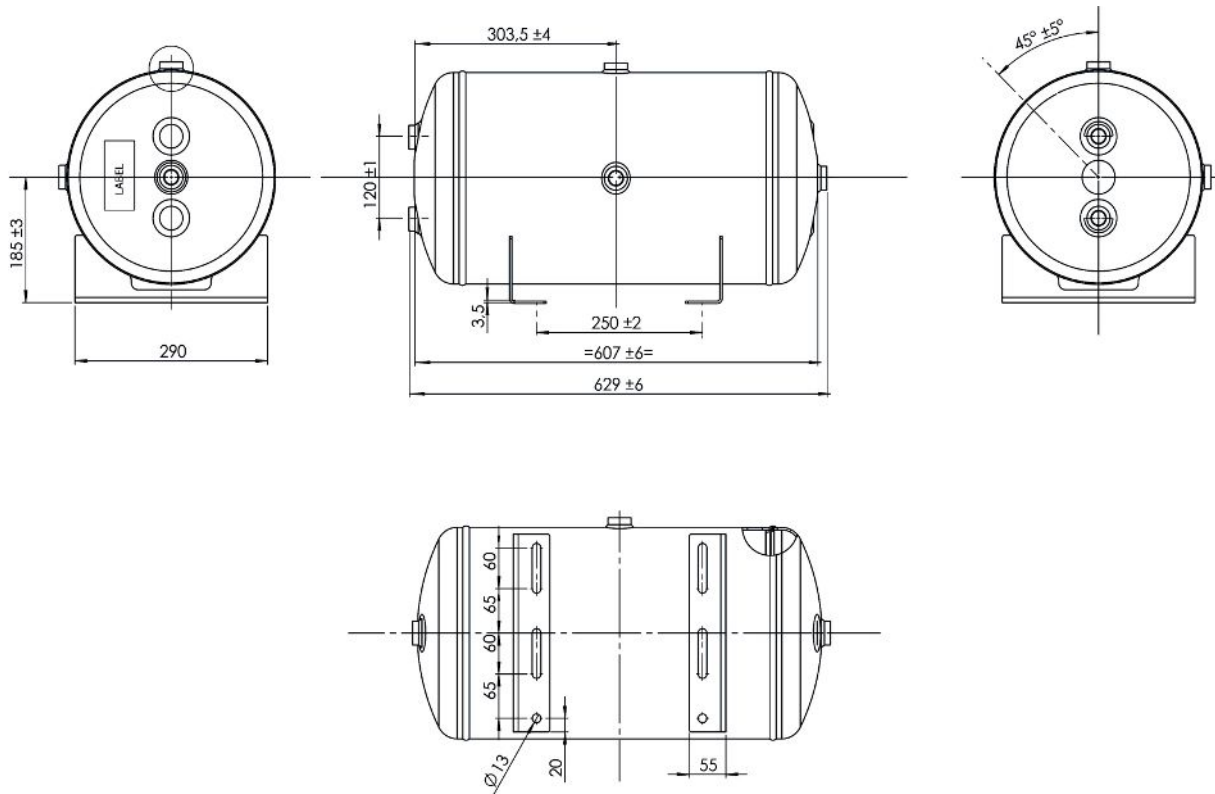

Onderdeelnummer ①	Ref. Nr. OEM ②	Toepassing	Volume	Ø mm	Bar
S1050046020	-	-	40	310	12,5

① Zie pagina 83

② De originele onderdeelnummers dienen alleen voor vergelijkingsdoeleinden en identificatie.





[www.sauer-qualityparts.com](http://www.sauer-qualityparts.com)



## SMEERMIDDELEN

Truck en Trailer onderdelen

## Lagervet, Draaikrans en Steunpoot vet

### Karakteristieken:

- Hoge temperatuur bestendigheid
- Oxidatie bestendig
- Waterbestendig
- Goede roest bescherming
- Goede adhesie karakteristieken
- Bruikbare temperaturen van -30°C tot +130°C



	Onderdeelnummer ①	Aantal	Verpakking	Omschrijving	Kleur
	S3870001000	400 g	Cartrige	SAUER FleetLube Longlife	blauw
	S3870001001	1 kg	Kan	SAUER FleetLube Longlife	blauw
	S3870001005	5 kg	Emmer	SAUER FleetLube Longlife	blauw
	S3870001018	18 kg	Emmer	SAUER FleetLube Longlife	blauw
	S3870001050	50 kg	Emmer	SAUER FleetLube Longlife	blauw
	S3870001008	180 kg	Vat	SAUER FleetLube Longlife	blauw

**Aanbevolen lagersmering voor de meeste trucks- en trailers.**

① Dit zijn SAUER QUALITY PARTS onderdeelnummers. Het zijn geen originele OEM of OEM geautoriseerde producten, maar het is een Aftermarket product.









[www.sauer-qualityparts.com](http://www.sauer-qualityparts.com)





## REMCILINDERS

Truck en Trailer onderdelen

## Membraancilinders voor remschijven

	Onderdeelnummer ①	SAF ②	BPW ②	Knorr ②	Wabco ②	Haldex ②	Type	Slag mm	Staal
	S4541110000	04454106560	0544432010	BS3300	4231047100	125160001	16"	64	✓
	S4541114000	04454106660	0544433010	BS3350	4231127100	342180000	18"	64	✓
	S4541111000	04454106760	0544434010	BS3404	4235050000	125200001	20"	64	✓
	S4541112000	04454106860	0544435010	BS3453	4231107100	342220000	22"	64	✓
	S4541113000	04454106960	0544436010	BS3532	4235060010	125240001	24"	64	✓

## Dubbel membraancilinders voor remschijven

	Onderdeelnummer ①	SAF ②	BPW ②	Knorr ②	Wabco ②	Haldex ②	Type	Slag mm	Alu	Staal
	S4541201000	04454107764	-	-	-	-	16/24"	64	-	✓
	S4541210000	04454104830	0544440010	BS7309	9253840100	1351624004	16/24"	64	✓	-
	S4541211000	04454107964	-	-	-	-	20/24"	64	-	✓
	S4541212000	04454105130	0544444010	BS7402	9253801010	1352024004	20/24"	64	✓	-

① Zie pagina 102



② De originele onderdeelnummers dienen alleen voor vergelijkingsdoeleinden en identificatie.

① Dit zijn SAUER QUALITY PARTS onderdeelnummers. Het zijn geen originele OEM of OEM geautoriseerde producten, maar het is een Aftermarket product.



## Luchtaansluiting remcilinder

	Onderdeel- nummer ①	Geschikt voor	BPW ②	Wabco ②	Haldex ②	Alu	Staal
	S4240001000	S4541201000 S4541211000	-	-	-	-	✓
	S4240002000	S4541210000 S4541212000	0500100050	9253800502	42593163	✓	-

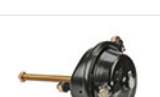
## Membraancilinders voor trommelremmen

	Onderdeelnummer ①	SAF ②	BPW ②	Knorr ②	Wabco ②	Haldex ②	Type	Slag mm	Zuigerstang mm
	S4542110000	–	0544413010	BZ3370	4231049000	123160001	16"	75	190
	S4542111000	04454108970	0544414010	BX3416	4231059000	123200001	20"	75	190
	S4542112000	04454109070	0544415040	BX3534	4231069000	123240001	24"	75	190
	S4542112100	–	0544415010	–	–	–	24"	76	190
	S4542113000	–	0544416010	BX3604	4231079000	123300001	30"	75	190

## Dubbel membraancilinders voor trommelremmen

	Onderdeelnummer ①	SAF ②	BPW ②	Knorr ②	Wabco ②	Haldex ②	Type	Slag mm	Zuigerstang mm
	S4542210000	04454109170	0544419010	BX7408	9253751000	136203000 1	20/30"	75	250
	S4542211000	04454109270	0544420010	BX7525	9253761000	136243000 1	24/30"	75	250
	S4542212000	–	0544421010	BX7611	9253771000	136303000 1	30/30"	75	250

① Zie pagina 102

② De originele onderdeelnummers dienen alleen voor vergelijkingsdoeleinden en identificatie.

## Gaffelset

	Onderdeelnummer ①	Omschrijving	Knorr ②	Wabco ②	Haldex ②
	S4240003000	Sleufgat	SEB01316	4230005352	003033609
	S4240004000	Rond gat	SEB01315	4230005342	003561409

## Veerremcilinder

	Onderdeelnummer ①	SAF ②	BPW ②	Knorr ②	Wabco ②	Haldex ②	Type	Slag mm	Staal
	S4541310010	–	0544441030	BS9378	9254644500 9254644507	–	16/16"	57	✓
	S4541310020	–	0544441040	BS9377	9254644510 9254644517	–	16/16"	57	✓

## Membraancilinders voor aslift

	Onderdeelnummer ①	SAF ②	BPW ②	Knorr ②	Wabco ②	Haldex ②	Type	Slag mm	Staal
	S4543110000	–	0544410370 0544410070	–	–	–	36"	90	✓

① Zie pagina 102

② De originele onderdeelnummers dienen alleen voor vergelijkingsdoeleinden en identificatie.





[www.sauer-qualityparts.com](http://www.sauer-qualityparts.com)



## STEUNPOTEN



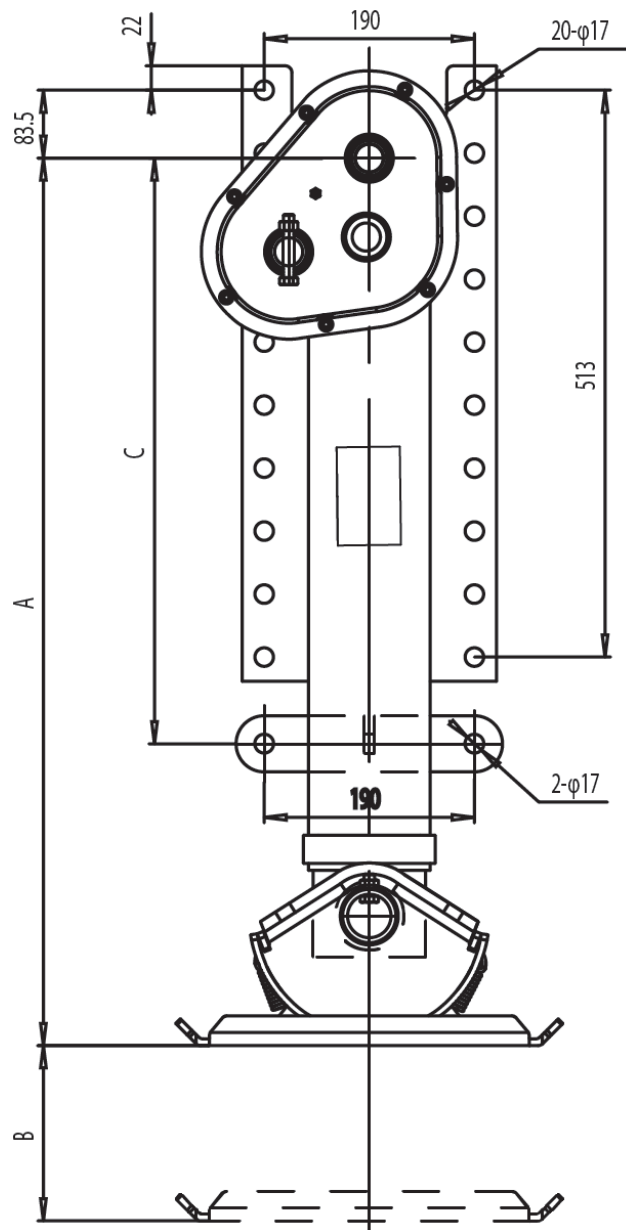





Truck en Trailer onderdelen



- Statische belasting per set: 50.000kg  
Statische belasting per steunpoot: 25.000kg
- Hefbelasting per set: 24.000kg  
Hefbelasting per steunpoot: 12.000kg
- De complete set wordt standaard geleverd inclusief:
  - Slingerhouder
  - Steunpootverbinding
  - Slinger



## Complete Set **BASIC**

	Omschrijving	Type	Onderdeelnummer ①	A mm	B mm	C mm	Gewicht kg
	<b>Veerpoot set met Veren voet</b>	LGS S 75-38 D S	S3897538100	750	382	480	104
	Veerpoot met Veren voet	LGS O 75-38 D S	S3897538110	750	382	480	44
	Veerpoot met Veren voet (Mechanisme)	LGS G 75-38 D S	S3897538120	750	382	480	52
	<b>Veerpoot set met Veren voet</b>	LGS S 80-44 D S	S3898044100	800	430	530	108
	Veerpoot met Veren voet	LGS O 80-44 D S	S3898044110	800	430	530	46
	Veerpoot met Veren voet (Mechanisme)	LGS G 80-44 D S	S3898044120	800	430	530	54
	<b>Veerpoot set met Veren voet</b>	LGS S 86-48 D S	S3898648100	860	480	580	112
	Veerpoot met Veren voet	LGS O 86-48 D S	S3898648110	860	480	580	48
	Veerpoot met Veren voet (Mechanisme)	LGS G 86-48 D S	S3898648120	860	480	580	56

① Dit zijn SAUER QUALITY PARTS onderdeelnummers. Het zijn geen originele OEM of OEM geautoriseerde producten, maar het is een Aftermarket product.

## Toebehoor

	Omschrijving	Onderdeelnummer ①	Gewicht kg
	Slinger	S2090001000	2,4
	Slingerhouder	S1890001000	0,3
	Vierkante stang	S4350001000	5,5
	Compensatievoet	S3700001000	12,0



[www.sauer-qualityparts.com](http://www.sauer-qualityparts.com)



## HUB UNITS

Truck en Trailer onderdelen

## Hub Units

	Onderdeelnummer ①	Omschrijving	Ref. Nr. OEM ②	Toepassing	Afmetingen
	S4340050000	Naafeenheid (Incl. O-ring / vet)	09400544 16000062 550017901	Fruehauf Gigant Krone	83/145/103
	S3410050000	Torx schroefset	709317791 550012912	Gigant Krone	M18x1,5x80
	S4340051000	Naafeenheid (Incl. O-ring / vet)	03434365000 1002689 1003457	SAF Schmitz Schmitz	82/196/114
	S3410051000	Torx schroefset	04343280110 04343280110012 015735 015736 016731 017873	SAF SAF Schmitz Schmitz Schmitz Schmitz	M18x1,5x65

① Zie pagina 112

② De originele onderdeelnummers dienen alleen voor vergelijkingsdoeleinden en identificatie.





[www.sauer-qualityparts.com](http://www.sauer-qualityparts.com)



# VERVANGINGSSET REMKLAUW

Truck en Trailer onderdelen



## Vervangingsset remklauw

	Onderdeelnummer ①	Omschrijving	Ref. Nr. OEM ②	Toepassing	Ref. Nr. OE ②	Geschikt voor
	S4340380100	Drukstuk	0980102630 1448913 1623221 42541341 42553530 5006046989 503512832 93162050 97131443 81508226007 81508226022 81508226032 A0004200682 A0004203982 A0004204882 11014051 5021133447 03434380400 1390429 1415151 1723414 1743421 1746824 1759811 2121859 015419 016703 016786 017264 11031121 1690420	BPW DAF DAF Iveco Iveco Iveco Iveco Iveco Iveco MAN MAN MAN Mercedes Benz Mercedes Benz Mercedes Benz Neoplan Renault SAF Scania Scania Scania Scania Scania Scania Scania Schmitz Schmitz Schmitz Schmitz Van Hool Volvo	K010604	Knorr - SB
	S4340380200	Geleidings/dichtingsset	0200603424 0980106330 1622786 1639100 1847716 42541412 JAE0150406174 6500508 81508226019 81508226034 81508226037 81508226044 A0004204682 A0004216174 03434381200 1477675 1527631 1723416 2121646 017899 11469228	BPW BPW DAF DAF DAF Iveco Jost Kögel MAN MAN MAN MAN Mercedes Benz Mercedes Benz SAF Scania Scania Scania Scania Schmitz Van Hool	K001915	Knorr - SN

① Zie pagina 114

② De originele onderdeelnummers dienen alleen voor vergelijkingsdoeleinden en identificatie.

## Vervangingsset remklauw



	Onderdeelnummer ①	Omschrijving	Ref. Nr. OEM ②	Toepassing	Ref. Nr. OE ②	Geschikt voor
	S4340380300	Drukstuk	0980106320 1622785 1689313 42541413 42552622 5006028046 JAE0150402382 JAE0150404982 6500509 550003848 81508226020 81508226031 A0004202382 A0004204082 A0004204982 5021171548 03434381400 1622785 1723417 17566389 2121858 2198394 017696 018050 1008451	BPW DAF DAF Iveco Iveco Iveco Jost Jost Kögel Krone MAN MAN Mercedes Benz Mercedes Benz Mercedes Benz Renault SAF Scania Scania Scania Scania Scania Schmitz Schmitz Schmitz	K010603	Knorr - SN/SK
	S4340380400	Geleidings/dichtingsset	1527854 6352308 550003849 A0004205082 03434381500 1748131 2121647 2198395 1006016 1008450 1105586	DAF Kögel Krone Mercedes Benz SAF Scania Scania Scania Schmitz Schmitz Schmitz	K108002K50	Knorr - SK/ST

① Zie pagina 114

② De originele onderdeelnummers dienen alleen voor vergelijkingsdoeleinden en identificatie.



## Vervangingsset remklauw





	Onderdeelnummer ①	Omschrijving	Ref. Nr. OEM ②	Toepassing	Ref. Nr. OE ②	Geschikt voor
	S4340380500	Geleidings/dichtingsset	0200603425 0980106310 1929023 5006028067 6610134 801933 801935 550018411 81508226023 81508226036 81508226043 A0004231450 A0004232574 5021171545 5021171547 03434382000 1472919 1504808 1723413 2064260 2292232 2653108 016787 016789 016790 1105585 1137206	BPW BPW DAF Iveco Kögel Kögel Kögel Krone MAN MAN MAN Mercedes Benz Mercedes Benz Renault Renault SAF Scania Scania Scania Scania Scania Scania Schmitz Schmitz Schmitz Schmitz Schmitz	K067417K50	Knorr - SB/SN
	S4340380600	Drukstuk	JAE0250410082 A0004230316 03434382300 2653108 1227579 1282317	Jost Mercedes Benz SAF Scania Schmitz Schmitz	K046523K50	Knorr - ST
	S4340380700	Geleidings/dichtingsset	1505890 6500510 550003851 03434382701 1723418 1748132 2093080 1020777 1062907	DAF Kögel Krone SAF Scania Scania Scania Schmitz Schmitz	12999738VT	Wabco PAN 19-1 / PAN 22-1

① Zie pagina 114

② De originele onderdeelnummers dienen alleen voor vergelijkingsdoeleinden en identificatie.









## Vervangingsset remklauw

	Onderdeelnummer ①	Omschrijving	Ref. Nr. OEM ②	Toepassing	Ref. Nr. OE ②	Geschikt voor
	S4340380800	Drukstuk	0906197 6353149 550003852 A4054210080 03434382900 1872780 2093084 2198528 2396938 1062929 1068160 1104515 50360001	DAF Kögel Krone Mercedes Benz SAF Scania Scania Scania Scania Schmitz Schmitz Schmitz Valx	6401759202	Wabco PAN 19-1 / PAN 22-1
	S4340380900	Geleidings/dichtingsset	16030004 703011013 JAE0250410063 6355949 550017677 550017811 03434386100 2092720 2119425 2305913 1173919	Gigant Gigant Jost Kögel Krone Krone SAF Scania Scania Schmitz	95397	Haldex / SAF - SBS
	S4340381000	Sperinrichting compleet	16030005 703011014 JAE0250410007 6609983 550017812 550018419 03434386200 2119426 2305914 1173930	Gigant Gigant Jost Kögel Krone Krone SAF Scania Scania Schmitz	95398	Haldex / SAF - SBS
	S4340381100	Drukstuk	16030006 703011015 JAE0250410086 6609981 550017813 03434386300 2092714 2305915 1173931	Gigant Gigant Jost Kögel Krone SAF Scania Scania Schmitz	95399	Haldex / SAF - SBS

① Zie pagina 114

② De originele onderdeelnummers dienen alleen voor vergelijkingsdoeleinden en identificatie.

## Vervangingsset remklauw

	Onderdeelnummer ①	Omschrijving	Ref. Nr. OEM ②	Toepassing	Ref. Nr. OE ②	Geschikt voor
	S4340381200	Geleidings/dichtingsset	0980102610 0980102870 1142142 1198153 1198154 1448915 5801109377 93162048 81508226009 A0004201282 A0004203015 A0014202883 5021133459 5021135225 1390427 2121643 015418 1052335	BPW BPW DAF DAF DAF DAF Iveco Iveco MAN Mercedes Benz Mercedes Benz Mercedes Benz Renault Renault Scania Scania Schmitz Schmitz	II369100062	Knorr - SB
	S4340381600	Geleidings/dichtingsset	1436853 42536957 1439494	DAF Iveco Volvo	12999699VT	Wabco PAN 17
	S4340381700	Geleidings/dichtingsset	1489197 5021202776 85102094	DAF Renault Volvo	MCK1116	MERITOR - DUCO
	S4340381800	Geleidings/dichtingsset	85102092	Volvo	MCK1118	MERITOR - DUCO
	S4340381900	Reparatieset Dichtring	1487339 503128757 81508026024 5006028414 5021179952 85107913	DAF Iveco MAN Renault Renault Volvo	MCK1139	MERITOR - ELSA / ELSA 2 / DUCO
	S4340382000	Geleidings/dichtingsset	1522058 42552052 42555201 503128758 81508026025 5001860791 85107912	DAF Iveco Iveco Iveco MAN Renault Volvo	MCK1243	MERITOR - ELSA 2
	S4340382100	Geleidings/dichtingsset	871054	Paccar	MCK1254	MERITOR - ELSA

① Zie pagina 114

② De originele onderdeelnummers dienen alleen voor vergelijkingsdoeleinden en identificatie.

## Vervangingsset remklauw

	Onderdeelnummer ①	Omschrijving	Ref. Nr. OEM ②	Toepassing	Ref. Nr. OE ②	Geschikt voor
	S4340382200	Geleidings/dichtingsset	5001866989 85109890	Renault Volvo	MCK1298	MERITOR - ELSA
	S4340382300	Drukstuk	5001866398 85109891	Renault Volvo	MCK1309	MERITOR - ELSA / ELSA 2
	S4340382400	Geleidings/dichtingsset	85109889	Volvo	MCK1317	MERITOR - ELSA
	S4340382500	Geleidings/dichtingsset	5001866560 22726389 21392594	Renault Scania Volvo	MCK1323	MERITOR - ELSA

① Zie pagina 114

② De originele onderdeelnummers dienen alleen voor vergelijkingsdoeleinden en identificatie.





[www.sauer-qualityparts.com](http://www.sauer-qualityparts.com)



## REMAN REM-KLAUWEN

Truck en Trailer onderdelen

## REMAN – Remkluuwen

Onderdeelnummer ①	Ref. Nr. OE ②	Geschikt voor	Omschrijving	Depositowaarde
S4000101000	K110129	Knorr SB/SN7	Dubbele balg	200,00 EUR
S4000102000	K110130	Knorr SB/SN7	Dubbele balg	200,00 EUR
S4000103000	K041389K50	Knorr SB/SN7	Dubbele balg	200,00 EUR
S4000104000	K041390K50	Knorr SB/SN7	Dubbele balg	200,00 EUR
S4000105000	K151739K50	Knorr SK7	Enkele balg	200,00 EUR
S4000106000	K151740K50	Knorr SK7	Enkele balg	200,00 EUR
S4000107000	K161919 K003786 K016516 K003804 K002786	Knorr SB/SN7	Enkele balg	200,00 EUR
S4000108000	K003783 K003785 K003803	Knorr SB/SN7	Enkele balg	200,00 EUR
S4000109000	K003782 K003796 K013182 K002709 K004579	Knorr SB/SN7	Enkele balg	200,00 EUR
S4000110000	K003781 K003795 K013181 K002708 K004578	Knorr SB/SN7	Enkele balg	200,00 EUR
S4000111000	K013174 K003826 K0013655	Knorr SB/SN6	Enkele balg	200,00 EUR
S4000112000	K013173 K003825 K0013656	Knorr SB/SN6	Enkele balg	200,00 EUR
S4000113000	K162130	Knorr SK7	Dubbele balg	200,00 EUR
S4000114000	K162131	Knorr SK7	Dubbele balg	200,00 EUR
S4000115000	K013176	Knorr SB/SN6	Enkele balg	200,00 EUR
S4000116000	K013175	Knorr SB/SN6	Enkele balg	200,00 EUR

① Zie pagina 122

② De originele onderdeelnummers dienen alleen voor vergelijkingsdoeleinden en identificatie.

## REMAN – Remklauwen

Onderdeelnummer ①	Ref. Nr. OE ②	Geschikt voor	Omschrijving	Depositowaarde
S4000117000	K003800 K013160 K002562	Knorr SB/SN7	Enkele balg	200,00 EUR
S4000118000	K003799 K013161 K002961	Knorr SB/SN7	Enkele balg	200,00 EUR
S4000119000	K003807	Knorr SB/SN7	Enkele balg	200,00 EUR
S4000120000	K003808	Knorr SB/SN7	Enkele balg	200,00 EUR
S4000121000	K003809 K003787 K040953K50	Knorr SB/SN7	Enkele balg	200,00 EUR
S4000122000	K003810	Knorr SB/SN7	Enkele balg	200,00 EUR
S4000123000	K002962	Knorr SB/SN7	Enkele balg	200,00 EUR
S4000124000	K002963	Knorr SB/SN7	Enkele balg	200,00 EUR
S4000125000	K040943K50	Knorr SB/SN7	Enkele balg	200,00 EUR
S4000126000	K040944K50	Knorr SB/SN7	Enkele balg	200,00 EUR
S4000127000	K052391K50	Knorr SM7	Enkele balg	200,00 EUR
S4000128000	K052390K50	Knorr SM7	Enkele balg	200,00 EUR
S4000129000	K052380K50	Knorr SL7	Enkele balg	200,00 EUR
S4000130000	K052381K50	Knorr SL7	Enkele balg	200,00 EUR
S4000131000	K052393K50	Knorr SM7	Enkele balg	200,00 EUR
S4000132000	K052392K50	Knorr SM7	Enkele balg	200,00 EUR
S4000133000	K003812	Knorr SB/SN7	Enkele balg	200,00 EUR
S4000134000	K003811	Knorr SB/SN7	Enkele balg	200,00 EUR
S4000135000	K003815 K010626	Knorr SB/SN7	Enkele balg	200,00 EUR
S4000136000	K003816 K010627	Knorr SB/SN7	Enkele balg	200,00 EUR

① Zie pagina 122

② De originele onderdeelnummers dienen alleen voor vergelijkingsdoeleinden en identificatie.

## REMAN – Remkluuwen

Onderdeelnummer ①	Ref. Nr. OE ②	Geschikt voor	Omschrijving	Depositowaarde
S4000137000	K013178	Knorr SB/SN6	Enkele balg	200,00 EUR
S4000138000	K013177	Knorr SB/SN6	Enkele balg	200,00 EUR
S4000139000	K041389K50	Knorr SB/SN7	Dubbele balg	200,00 EUR
S4000140000	K041390K50	Knorr SB/SN7	Dubbele balg	200,00 EUR
S4000301000	LRG572	MERITOR/ROR ELSA 2	Dubbele balg	200,00 EUR
S4000302000	LRG573	MERITOR/ROR ELSA 2	Dubbele balg	200,00 EUR
S4000303000	LRG782	MERITOR/ROR ELSA 195	Dubbele balg	200,00 EUR
S4000304000	LRG783	MERITOR/ROR ELSA 195	Dubbele balg	200,00 EUR
S4000305000	LRG728	MERITOR/ROR ELSA 225-3	Dubbele balg	200,00 EUR
S4000306000	LRG729	MERITOR/ROR ELSA 225-3	Dubbele balg	200,00 EUR
S4000307000	LRG726	MERITOR/ROR ELSA 225-3	Dubbele balg	200,00 EUR
S4000308000	LRG727	MERITOR/ROR ELSA 225-3	Dubbele balg	200,00 EUR
S4000309000	LRG730	MERITOR/ROR ELSA 225-1	Dubbele balg	200,00 EUR
S4000310000	LRG731	MERITOR/ROR ELSA 225-1	Dubbele balg	200,00 EUR

① Zie pagina 122

② De originele onderdeelnummers dienen alleen voor vergelijkingsdoeleinden en identificatie.





Contact

## EERLIJK

- De juiste prijs voor het juiste onderdeel - overal en altijd!

## BEWEZEN

- Na vele jaren op de weg verdient uw voertuig nog steeds geteste onderdelen voor een lange levensduur. Uw truck en trailer verdienen de juiste producten, zodat ze optimaal blijven presteren!

## BETROUWBAAR

- Het is niet alleen dat we betrouwbare kwaliteitsonderdelen leveren in een van de meest veeleisende markten. Wij zijn een partner waar u op kunt vertrouwen!