



www.sauer-qualityparts.com



TAMBURI FRENO

Ricambi per motrici,
rimorchi e semirimorchi

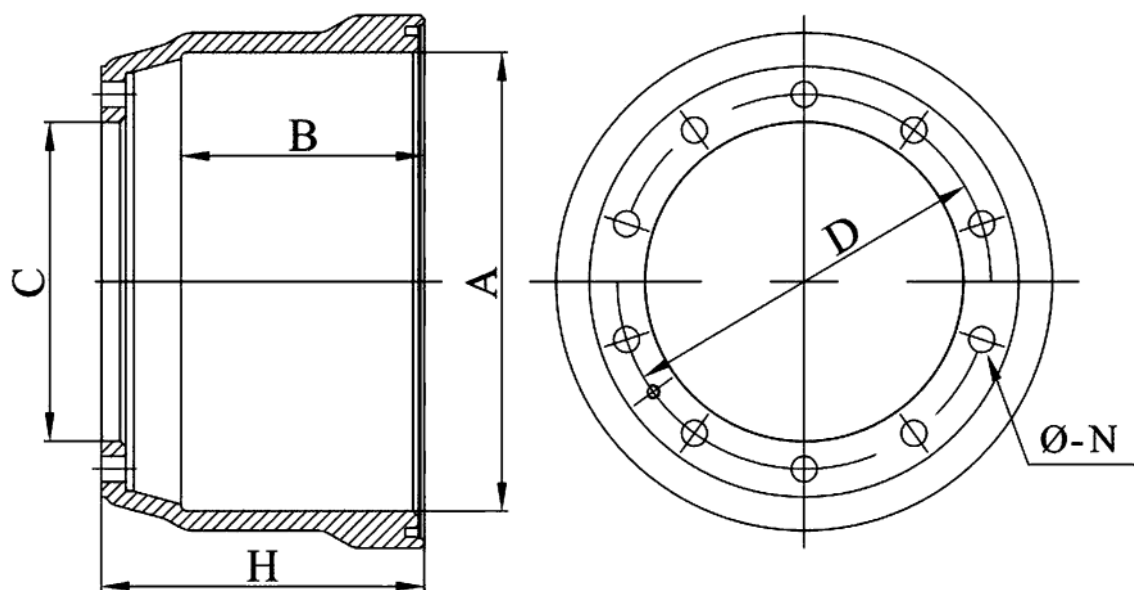

Tamburi freno

	Codice n° ①	Riferimento codice Costruttore ②	Applicazione	A	B	C	H	D	Ø N	N° di fori
	S0640119700	01064019700	SAF	300	212,5	190	280	225	23	10
	S0640126000	01064026001 01064026002	SAF	420	195	300	226,5	335	23	10
	S0640127000	01064027000 1004661	SAF Schmitz	420	219	300	255,5	335	23	10
	S0640127300	550002237 01064027300 1044330	Krone SAF Schmitz	300	212	190	280	225	23	10
	S0640203000	0310990030	BPW	360,2	200,5	230	260	275	23	8
	S0640206000	0310946060 0310946070	BPW	300,2	210	190	260	225	23	10
	S0640216000	0310977160 0310977570 0310977770 012266 018083	BPW BPW BPW Schmitz Schmitz	420	215	290	260	335	23	10
	S0640217000	0310977170 0310977420 0310977330	BPW	420,2	215	290	259,5	335	23	10
	S0640218000	0310977180 0310977230 0310977430	BPW	420,2	225	290	285	335	23	10
	S0640219000	0310967190 0310967290 0310967790 0910967790 550015680 5021202644	BPW BPW BPW BPW Krone Renault	420,2	191,5	290	226	335	23	10

① Vedi pagina 3

② I numeri originali dei prodotti sono solo a scopo di confronto ed identificazione.

① Questi sono codici SAUER QUALITY PARTS. Questi non sono prodotti originali del costruttore (OEM = Original equipment Manufacturer) o prodotti autorizzati dal costruttore ma un ricambio indipendente.

Tamburi freno

	Codice n° ①	Riferimento codice Costruttore ②	Applicazione	A	B	C	H	D	Ø N	N° di fori
	S0640222000	0310990220 0310590020	BPW	360	209	230	263	275	23	8
	S0640249000	0310546290 0310946490	BPW	300	210,5	190	260	225	23	10
	S0640262000	0310667620 0310967820 0310967130	BPW	420	194	290	230	335	23	10
	S0640300110	A6584210001 A6864210001 A6244210201	Mercedes Benz	410	191	298	237	335	23	10
	S0640327110	A3874210201 A6584210301	Mercedes Benz	410	192,5	298	260	335	23	10
	S0640340110	A3054210401 A3054210101 A3054210001 A3054230601 A3564210001	Mercedes Benz	410	167	298	213	335	23	10
	S0640340120	81501100122 A3054230201 A3054230301 A3054230401 A3054230701 A3554230301	MAN Mercedes Benz Mercedes Benz Mercedes Benz Mercedes Benz Mercedes Benz	410	238	298	306	335	23	10
	S0640401200	1599012	Volvo	410	231,5	282	410	231,5	282	10
	S0640430600	7421451969 1075306 1599009 21094122 21451966 3171744	Renault Volvo Volvo Volvo Volvo Volvo	410	199	282	260	335	28	10

① Vedi pagina 3

② I numeri originali dei prodotti sono solo a scopo di confronto ed identificazione.

Tamburi freno

	Codice n° ①	Riferimento codice Costruttore ②	Applicazione	A	B	C	H	D	Ø N	N° di fori
	S0640430900	7420713927 7421359819 7421451973 1075309 21094123 21451967 21508812 31508812 3171747	Renault Renault Renault Volvo Volvo Volvo Volvo Volvo Volvo	410	218	282	294	335	28	10
	S0640431320	1590313 1134818	Volvo	394	266	282	314	335	28	10
	S0640481710	1134817	Volvo	394	218	282	269	335	28	10
	S0640514400	81501100144 81501100107 81501100104 81501100200 81501100245 81501100244 64501100002	MAN	410	232	298	300	335	23	10
	S0640521310	81501100213 81501100118 81501100242	MAN	410	172	298	250	335	23	10
	S0640523200	81501100232 81501100227 81501100214 81501100239	MAN	410	188	298	232	335	23	10
	S0640615200	1414152 1334075 392391	Scania	413	189	295	263	335	23,5	10
	S0640633110	1414153 1361331 392386 1333117 1381331 360571 2109552 2378715	Scania	413	213	295	275	335	23,5	10

① Vedi pagina 3

② I numeri originali dei prodotti sono solo a scopo di confronto ed identificazione.







Tamburi freno

	Codice n° ①	Riferimento codice Costruttore ②	Applicazione	A	B	C	H	D	Ø N	N° di fori
	S0640643500	1414435 1385893 293543 360573 305438 342880 2109553 2378716	Scania	413	266	295	321	335	23,5	10
	S0640705000	7183050	Iveco	410	213	285	290	335	23	10
	S0640742700	42118427 42102583	Iveco	410	211	285	282	335	23	10
	S0640876800	5000737768 5010019220	Renault	414	182	280,8	230	335	25	10
	S0640894900	5010098949 5001019218	Renault	414	232	280,8	278	335	26,5	10
	S0640911400	21021114AV 21023064 21020038 21021164	MERITOR/ROR	419,1	230	283	272	335	24,5	10
	S0640918300	21219028 21220183AV 22222978 22224179 21223852	MERITOR/ROR	419	188	283	238	335	24,25	10
	S0640996300	21018963 21209723S 21023036	MERITOR/ROR	311	202	183	260	225	24,25	10
	S0640998600	21018986V 21021163 21021284	MERITOR/ROR	419	199	283	248	335	24,5	10

① Vedi pagina 3

② I numeri originali dei prodotti sono solo a scopo di confronto ed identificazione.

Tamburi freno

	Codice n° ①	Riferimento codice Costruttore ②	Applicazione	A	B	C	H	D	Ø N	N° di fori
	S0641039700	754397 075983	DAF	420	213	285	287,5	335	24	10
	S0641046200	1233462 595225 94903 284620	DAF	420	163	285	230	335	24	10
	S0641080600	1232806 275824 90498	DAF	420	192	285	251	335	24	10
	S0641239700	730397 7303097 Y00000227	SAE/Gigant	305	210	175,8	284	225	26,5	10
	S0641300200	1030341 AJB0465001 M003176 7000085S 449628 AJB0465002	SMB/Fruehauf	419	215	288	256	335	26,5	10
	S0641503700	1008 09380037 709380037 Y00006429 YO11004098	SAE/Gigant	300	205	180	260	225	26,5	10
	S0641516000	790160 Y11000251	SAE/Gigant	305	210	175,8	256,5	225	26,5	10

① Vedi pagina 3

② I numeri originali dei prodotti sono solo a scopo di confronto ed identificazione.

Fornito da

CORRETTO

- Prezzo giusto per il ricambio corretto - ovunque e in ogni momento!

TESTATO

- Dopo tutti questi anni sulla strada il veicolo merita ancora componenti testati per lunghe durate - camion e rimorchio ti ringrazieranno lavorando tutti i giorni!

AFFIDABILE

- Non offriamo solo componenti di qualità in un mercato esigente e ricambi per mantenere il tuo business sempre attivo - noi siamo un partner di cui ti puoi fidare!